

Hardware Specifications

MONITOUCH

V606e



Record of Revisions

Reference numbers are shown at the bottom left corner on the back cover of each manual.

| Printing Date | Reference No. | Revised Contents |
|---------------|---------------|------------------|
| March, 2004 | 2013NE0 | First edition |
| | | |

Preface

Thank you for selecting the MONITOUCH V606e.

For correct set-up of the V606e, you are requested to read through this manual to understand more about the product.

For more information about the V606e, refer to the following related manuals.

| Manual Name | Contents | Reference No. |
|----------------------------------|--|---------------|
| Reference Manual (Operation) | The V-SFT operating procedure is described. | 1043NE |
| Reference Manual (Function) | The functions and instructions of the V7/V6 series are explained. | 1044NE |
| PLC Connection Manual | Connections with various PLCs and universal serial communications are explained. | 2200NE |
| Temperature Control Network | The temperature control network function is explained. | 1033NE |
| Connection with AB Control Logix | The connection, communication parameters and tag setting for AB Control Logix are explained. | 1041NE |
| M-CARD SFT Operation Manual | The operating procedure of the memory card editor is described. | 1023NE |
| V-SFT Additional Specifications | Additional specifications for the Reference Manual are explained. | 5044NE |

For further details about PLCs (programmable logic controllers), see the manual attached to each PLC.

Notes:

1. This manual may not, in whole or in part, be printed or reproduced without the prior written consent of Hakko Electronics Co., Ltd.
2. The information in this manual is subject to change without prior notice.
3. Windows and Excel are registered trademarks of Microsoft Corporation in the United States and other countries.
4. All other company names or product names are trademarks or registered trademarks of their respective holders.
5. This manual is intended to give accurate information about MONITOUCH hardware. If you have any questions, please contact your local distributor.

Notes on Safe Use of MONITOUCH

In this manual, you will find various notes categorized under the following levels with the signal words "DANGER," and "CAUTION."



DANGER

Indicates an imminently hazardous situation which, if not avoided, will result in death or serious injury.



CAUTION

Indicates a potentially hazardous situation which, if not avoided, may result in minor or moderate injury and could cause property damage.

Note that there is a possibility that the item listed with  CAUTION may have serious ramifications.



DANGER

- Never use the input function of MONITOUCH for operations that may threaten human life or to damage the system, such as switches to be used in case of emergency. Please design the system so that it can cope with malfunction of a touch switch. A malfunction of the touch switch will result in machine accident or damage.
- Turn off the power supply when you set up the unit, connect cables or perform maintenance and inspection. Otherwise, electrical shock or damage may occur.
- Never touch any terminals while the power is on. Otherwise, electric shock may occur.
- You must put a cover on the terminals on the unit when you turn the power on and operate the unit. Without the terminal cover in place, an electric shock may occur.
- The liquid crystal in the LCD panel is a hazardous substance. If the LCD panel is damaged, never swallow the leaked liquid crystal. If the liquid crystal spills on your skin or clothing, use soap and wash off thoroughly.
- For MONITOUCH using a lithium battery, never disassemble, recharge, deform by pressure, short-circuit, nor reverse the polarity of the battery, and never dispose of the battery in fire. Failure to follow these conditions will lead to explosion or ignition.
- For MONITOUCH using a lithium battery, never use a battery that is deformed, leaks, or shows any other signs of abnormality. Failure to follow these conditions will lead to explosion or ignition.

CAUTION

- Check the appearance of the unit when it is unpacked. Do not use the unit if any damage or deformation is found. Failure to do so may lead to fire, damage or malfunction.
- For use in a facility or for a system related to nuclear energy, aerospace, medical, traffic equipment, or mobile installations, please consult your local distributor.
- Operate (or store) MONITOUCH under the conditions indicated in this manual and related manuals. Failure to do so could cause fire, malfunction, physical damage or deterioration.
- Understand the following environmental limits for use and storage of MONITOUCH. Otherwise, fire or damage to the unit may result.
 - Avoid locations where there is a possibility that water, corrosive gas, flammable gas, solvents, grinding fluids or cutting oil can come into contact with the unit.
 - Avoid high temperature, high humidity, and outside weather conditions, such as wind, rain or direct sunlight.
 - Avoid locations where excessive dust, salt, and metallic particles are present.
 - Avoid installing the unit in a location where vibration or physical shock may be transmitted.
- Equipment must be correctly mounted so that the main terminal of MONITOUCH will not be touched inadvertently. Otherwise, an accident or electric shock may occur.
- Tighten the fixtures of the MONITOUCH with a torque in the specified range. Excessive tightening may distort the panel surface. Loose tightening may cause MONITOUCH to come off, malfunction or be short-circuited.
- Check periodically that terminal screws on the power supply terminal block and fixtures are firmly tightened. Loosened screws may result in fire or malfunction.
- Tighten terminal screws on the power supply terminal block equally to a torque of 0.5 N•m. Improper tightening of screws may result in fire, malfunction, or trouble.
- MONITOUCH has a glass screen. Do not drop or give physical shock to the unit. Otherwise, the screen may be damaged.
- Connect the cables correctly to the terminals of MONITOUCH in accordance with the specified voltage and wattage. Over-voltage, over-wattage or incorrect cable connection could cause fire, malfunction or damage to the unit.
- The 24 V power line in MONITOUCH is equipped with a varistor. Since an insulation resistance test (500 V megger) or withstand voltage test (500 VAC) on MONITOUCH may damage the varistor, do not conduct these tests.
- Be sure to establish a ground of MONITOUCH. Ground FG terminal which must be used for the unit. Otherwise, electric shock or a fire may occur.
- Prevent any conductive particles from entering into MONITOUCH. Failure to do so may lead to fire, damage or malfunction.
- After wiring is finished, remove the paper used as a dust cover before starting to operate MONITOUCH. Operation with the cover attached may result in accident, fire, malfunction, or trouble.
- Do not attempt to repair MONITOUCH at your site. Ask Hakko or the designated contractor for repair.
- Do not disassemble or modify MONITOUCH. Otherwise, it may cause a malfunction.
- Hakko Electronics Co., Ltd. is not responsible for any damages resulting from repair, overhaul or modification of MONITOUCH that was performed by an unauthorized person.
- Do not use a sharp-pointed tool when pressing a touch switch. Doing so may damage the screen.
- Only experts are authorized to set up the unit, connect the cables or perform maintenance and inspection.
- For MONITOUCH using a lithium battery, handle the battery with care. The combustible materials such as lithium or organic solvent contained in the battery may generate heat, explode, or catch fire, resulting in personal injury or fire. Read related manuals carefully and handle the lithium battery correctly as instructed.
- When using a MONITOUCH that has analog switch resolution with resistance film, do not press two or more points on the screen at the same time. If there is a switch between the two pressed points, it may be activated.
- Take safety precautions during such operations as setting change during running, forced output, start, and stop. Any misoperation may cause unexpected machine motions, resulting in machine accident or damage.
- In facilities where a failure of MONITOUCH could lead to accident threatening human life or other serious damage, be sure that the facilities are equipped with adequate safeguards.
- At the time of disposal, MONITOUCH must be treated as industrial waste.
- Before touching MONITOUCH, discharge static electricity from your body by touching grounded metal. Excessive static electricity may cause malfunction or trouble.

[General Notes]

- Never bundle control cables and input/output cables with high-voltage and large-current carrying cables such as power supply cables. Keep these cables at least 200 mm away from the high-voltage and large-current carrying cables. Otherwise, malfunction may occur due to noise.
- When using MONITOUCH in an environment where a source of high-frequency noise is present, it is recommended that the FG shielded cable (communication cable) be grounded at its ends. However, the cable may be grounded only at one end if this is necessary due to unstable communication conditions or for any other reason.
- Plug connectors or sockets of MONITOUCH in the correct orientation. Otherwise, it may cause a malfunction.
- Do not use thinners for cleaning because they may discolor the MONITOUCH surface. Use alcohol or benzine commercially available.
- If a data receive error occurs when MONITOUCH and the counterpart (PLC, temperature controller, etc.) are started at the same time, read the manual for the counterpart unit and handle the error correctly.
- Avoid discharging static electricity on the mounting panel of the MONITOUCH. Static charges can damage the unit and cause malfunctions. Otherwise, malfunction may occur due to noise.
- Avoid prolonged display of any fixed pattern. Due to the characteristics of the liquid crystal display, an afterimage may occur. If a prolonged display of a fixed pattern is expected, use the auto OFF function of the backlight.
- The V606e has no electrical insulation between 0 V for the input power supply and 0 V for the internal voltage (SG), or for the communication circuit (non-insulated power system used). Take this into account in system design.

Contents

| | |
|---|--|
| Preface | |
| Notes on Safe Use of MONITOUCH | |
| Chapter 1 | Overview |
| 1. | Features..... 1-1 |
| 2. | Models and Peripheral Equipment..... 1-2 |
| MONITOUCH Models | 1-2 |
| Peripheral Equipment..... | 1-3 |
| 3. | System Composition 1-5 |
| Chapter 2 | Specifications |
| 1. | Specifications..... 2-1 |
| General Specifications | 2-1 |
| Display Specifications | 2-2 |
| Touch Switch Specifications | 2-2 |
| Function Switch Specifications..... | 2-2 |
| Interface Specifications | 2-3 |
| Clock and Backup Memory Specifications | 2-3 |
| Drawing Environment..... | 2-3 |
| Display Function Specifications | 2-4 |
| Function Performance Specifications..... | 2-5 |
| 2. | Dimensions and Panel Cut-out 2-6 |
| 3. | Names and Functions of Components..... 2-7 |
| 4. | Serial Connector (CN1)..... 2-8 |
| Serial Connector for PLC Connection | 2-8 |
| 5. | Modular Jack (MJ1) 2-9 |
| V-SFT Setting..... | 2-9 |
| Transferring Screen Data | 2-10 |
| Barcode Reader Connection..... | 2-10 |
| Connection with Printer through Serial Interface..... | 2-11 |
| Chapter 3 | Installation |
| 1. | Mounting Procedure..... 3-1 |
| Mounting Procedure | 3-1 |
| Mounting Angle | 3-1 |
| 2. | Power Supply Cable Connection 3-2 |
| Power Supply Cable Connection | 3-2 |
| Grounding | 3-2 |
| Chapter 4 | Instructions |
| 1. | Coin-type Lithium Battery (V606eX20 only)..... 4-1 |
| Battery Mounting Procedure | 4-1 |
| Battery Replacement..... | 4-2 |
| 2. | DIP Switch Setting 4-4 |
| DIP Switch (DIPSW) Setting | 4-4 |
| 3. | Function Switches..... 4-5 |
| Types | 4-5 |
| [SYSTEM] Switch..... | 4-5 |

Chapter 5 Connections

| | |
|--|-----|
| 1. 1 : 1 Connection | 5-1 |
| 2. 1 : n Connection (Multi-drop)..... | 5-2 |
| 3. n : 1 Connection (Multi-link 2) | 5-3 |
| 4. n : 1 Connection (Multi-link) | 5-4 |
| 5. Universal Serial Communications | 5-5 |
| 6. V-Link | 5-6 |
| 7. PLC2Way | 5-7 |
| 8. Temperature Control Network..... | 5-8 |

Chapter 6 MONITOUCH Operations

| | |
|---|------|
| 1. Operational Procedures | 6-1 |
| MONITOUCH Operation | 6-1 |
| 2. Main Menu Screen | 6-3 |
| Displaying the Main Menu Screen | 6-3 |
| Moving Back to the Screen in the RUN Mode | 6-3 |
| Main Menu Screen..... | 6-4 |
| 1. I/O Test | 6-4 |
| 1-1. Serial Connection Test..... | 6-5 |
| 1-2. SYSTEM & Function Switch Test..... | 6-8 |
| 1-3. Touch Switch Test..... | 6-8 |
| 2. Memory Card Screen..... | 6-10 |
| 3. Communication Parameter Screen..... | 6-13 |
| 4. SRAM/Clock | 6-14 |
| 5. Extension Program Information | 6-15 |
| 6. Extended Function Setting..... | 6-16 |

Chapter 7 Error Correction

| | |
|---------------------------------|-----|
| 1. Error Message..... | 7-1 |
| 1. Communication Error..... | 7-1 |
| 2. Check..... | 7-3 |
| 3. Warning | 7-3 |
| 4. SYSTEM ERROR | 7-4 |
| 5. Touch Switch is Active | 7-4 |
| 2. Troubleshooting | 7-5 |
| In the Event of an Error..... | 7-5 |
| Probable Symptoms..... | 7-5 |

Chapter 8 Inspection and Maintenance

| | |
|-------------------------------------|-----|
| 1. Inspection and Maintenance | 8-1 |
| Daily Inspection..... | 8-1 |
| Periodical Inspection..... | 8-1 |
| 2. Warranty Policy | 8-2 |
| Inquiries about Failure | 8-2 |
| Warranty Period..... | 8-2 |
| Free-of-charge Repair..... | 8-2 |
| Chargeable Repair..... | 8-2 |
| Inquiry Form..... | 8-3 |

1

Overview

1. Features
2. Models and Peripheral Equipment
3. System Composition

1. Features

The V606e inherits and heightens the features of the V6 series as described below.

1. Low-cost Standard Model

The V606e is a low-cost model adapted to provide the minimum necessary functions.

This compact model, just 44.0 mm thick with a simple interface, is ideal for cost reduction.

Two types with a 16-color display and an 8-step gradation white mode display are available. Only analog switches are usable on the V606e.

2. One MJ Port Provided as Standard

Only one MJ port is provided in line with providing the minimum necessary functions.

The functions listed below can be used through MJ1.

- Card recorder
- Barcode reader
- V-I/O
- Multi-link 2
- Temperature control network/PLC2Way
- V-Link
- Ladder transfer function
- Modbus slave communication
- Printer port (serial)

* When the simulator is used, MJ1 must be selected as [Editor Port]. This means that the functions listed above cannot be used.

3. Brightness Adjustment with Macro Command

The brightness is adjustable with the macro command BRIGHT.

Use this adjustment function together with the contrast adjustment.

4. For V606eX20

V606eX20 contains a 128 kbyte SRAM.

It can be used for purposes including the built-in clock function, history data backup, and nonvolatile memory \$L.

* The V606e is not equipped with a printer port (parallel). When connecting to a printer, use the serial port (MJ1).

2. Models and Peripheral Equipment

MONITOUCH Models

The model name consists of the following information.

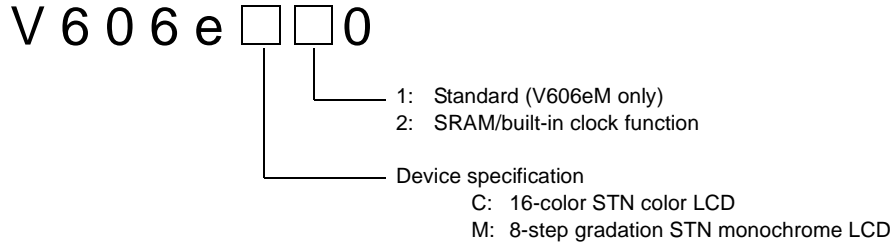

The following models are available.

| Series and Size | Model Name | Specifications | Remarks |
|--------------------------|------------|--|--------------------------|
| V606e series 5.7-inch | V606eM10 | STN monochrome 8-step gradation, 320 × 240 dots, analog switch, standard | Compliant with CE/UL/cUL |
| | V606eM20 | STN monochrome 8-step gradation, 320 × 240 dots, analog switch, SRAM/built-in clock function | Compliant with CE/UL/cUL |
| | V606eC20 | STN 16-color, 320 × 240 dots, analog switch, SRAM/built-in clock function | Compliant with CE/UL/cUL |

Peripheral Equipment

The following options are available for using the V606e more effectively.



V-SFT (configuration software: English version)

Application software for editing display data for the MONITOUCH.
(Windows98/NT4.0/Me/2000/XP compatible)
The V606e is supported with ver. 2.2.1.0 and later.

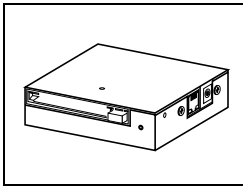

CREC (card recorder)

The card recorder creates a backup copy of screen data or works as an external memory storage system for memory manager and data logging functions.

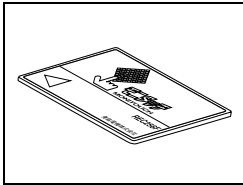

REC-MCARD (memory card) compliant with JEIDA ver. 4.0

Used with the card recorder when having a backup copy of screen data or saving data on an external medium for memory manager and data logging functions.

SRAM 256 k, 512 k, 1 M, 2 M, 4 Mbyte
FLASH ROM 256 k, 512 k, 1 Mbyte



M-CARD SFT (memory card editor)

Application software for editing data stored on a memory card, SRAM or CF card.
(Windows98/NT4.0/Me/2000/XP compatible)

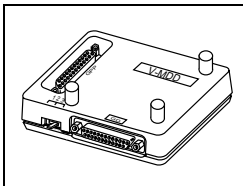

V-MDD (ACPU/QnACPU/FXCPU dual port interface)

Add-on connector with two ports, specifically designed for the connector on the MITSUBISHI's ACPUCPU/QnACPU/FXCPU programmer. Operability can be improved when directly connecting the V606e to the ACPUCPU/QnACPU/FXCPU programmer.

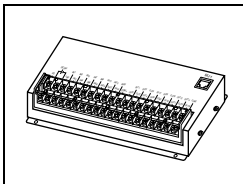

V-I/O (serial extension I/O)

Used as an external I/O unit for PLC. It has 16 inputs and 16 outputs.

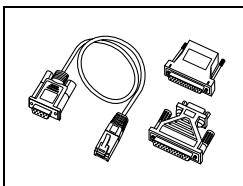

V6-CP (screen data transfer cable) 3 m

Used for connection between the V606e and a personal computer, or a personal computer and the card recorder (CREC).

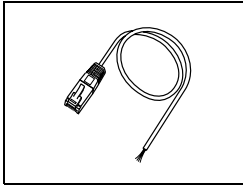

V6-BCD (barcode reader connection cable) 3 m
Used for connection between the V606e and a barcode reader.

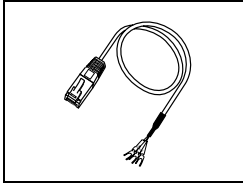

V6-MLT (multi-link 2 master cable) 3 m
Used for Multi-Link 2 connection between the V606e master station and the V606e slave station.

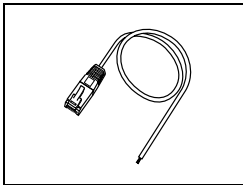

V6-TMP (temperature controller connection cable) 3 m
Used for connection between the V606e and a temperature controller or a PLC via PLC2Way.

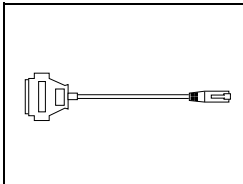

MJ-D25 (MJ-to-D-sub conversion cable) 0.3 m
Used for connection between the V606e and a PLC via PLC2Way.

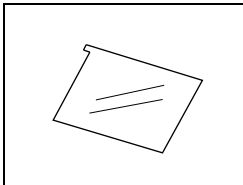

V606-GS (protective sheet)
This sheet protects the operation panel surface. (5 sheets/set)

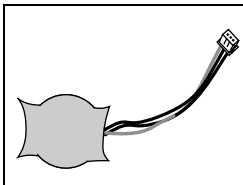

V7-BT (battery for replacement)
Replacement lithium battery for the V606e.

* The devices below are not usable with the V606e.

| Model | Name |
|----------|------------------------|
| TC485 | Terminal converter |
| CU-xx | Communication I/F unit |
| V6-PT | Printer cable |
| V6EM/4i | FROM cassette |
| V6EM/RSi | SRAM cassette |

3. System Composition

The following illustration shows possible system configurations using the V606e.

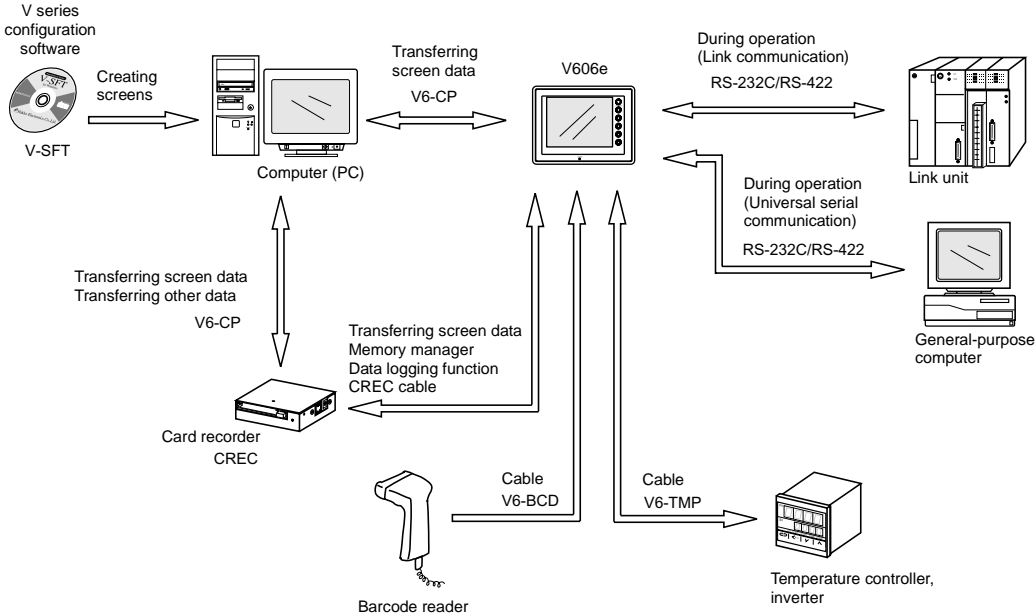

MEMO

Please use this page freely.

2 Specifications

1. Specifications
2. Dimensions and Panel Cut-out
3. Names and Functions of Components
4. Serial Connector (CN1)
5. Modular Jack (MJ1)

1. Specifications

General Specifications

| | Item | Specifications |
|-------------------------------|--|--|
| Power Supply | Rated Voltage | 24 VDC |
| | Permissible Range of Voltage | 24 VDC \pm 10% *1 |
| | Permissible Momentary Power Failure | Within 1 ms |
| | Power Consumption (Maximum Rating) | 10 W or less |
| | Rush Current | 10 A, 1 ms |
| Physical Environment | Ambient Temperature | 0°C to +50°C *2 |
| | Storage Ambient Temperature | -10°C to +60°C |
| | Ambient Humidity | 85% RH or less (without dew condensation) |
| | Solvent Resistance | No cutting oil or organic solvent attached to the unit |
| | Atmosphere | No corrosive gas or conductive dust |
| Mechanical Working Conditions | Vibration Resistance | Vibration frequency: 10 to 150 Hz, Acceleration: 9.8 m/s ² (1.0G) Single amplitude: 0.075 mm, X, Y, Z: 3 directions for one hour |
| | Shock Resistance | Pulse shape: Sine half wave Peak acceleration: 147 m/s ² (15G), X, Y, Z: 3 directions six times each |
| Electrical Working Conditions | Noise Resistance | 1000 Vp-p (pulse width 1 μ s, rise time: 1 ns) |
| | Static Electricity Discharge Resistance | Compliant with IEC61000-4-2, contact: 6 kV, air: 8 kV |
| Mounting Conditions | Grounding | Grounding resistance: less than 100 Ω |
| | Structure | Protection structure: Front panel: compliant with IP65 (when using waterproof gasket) Rear case: compliant with IP20 Form: In a single body Mounting procedure: Inserted in a mounting panel |
| | Cooling System | Cooling naturally |
| | Weight | Unit only: approx. 800 g |
| | External Dimensions W \times H \times D (mm) | 181.6 \times 138.8 \times 44 |
| | Panel Cut-out Dimensions (mm) | 174 ^{+0.5} ₀ \times 131 ^{+0.5} ₀ |
| Case Color | Black (Munsell N2.0) | |
| Case Material | PC/PS resin (Tarflon) | |

*1 The V606e has no electrical insulation between 0 V for the input power supply and 0 V for the internal voltage (SG), or for the communication circuit (non-insulated power system used). Take this into account in system design.

*2 Operation for long hours at ambient temperatures of 40 to 50°C may degrade the display quality, such as lowering contrast.

Display Specifications

| Item | Model | |
|--------------------------------------|--|----------------------------|
| | V606eC | V606eM |
| Display Device | STN color LCD | STN monochrome LCD |
| Display Size | 5.7-inch | |
| Colors | 16 color + blink | Monochrome 8-grade + blink |
| Resolution | W × H (dots) 320 × 240 | |
| Dot Pitch | W × H (mm) 0.36 × 0.36 | |
| Brightness (cd/m ²) | 160 | 220 |
| Contrast Ratio | 55 : 1 | 10 : 1 |
| Angle of Vertical Visibility (°) | -40, +20 | |
| Angle of Horizontal Visibility (°) | ±45 | |
| Backlight | Cold cathode rectifier (cannot be replaced by users) | |
| Average Backlight Life* ¹ | Approx. 54,000 h | Approx. 50,000 h |
| Backlight Auto OFF Function | Always ON, random setting | |
| Contrast Adjustment | Provided * ² | |
| Brightness Adjustment | Provided * ³ | |
| Surface Sheet | Material: PET (188 μm, non-glare high-transmittance surface) | |
| POWER Lamp | Illuminated when the power is on | |

*1 When the normal temperature is 25°C, and the surface luminance of the display is 50% of the initial setting

*2 Adjustable with function switches

*3 Adjustable with the macro command

Touch Switch Specifications

| Item | Specifications |
|-------------------|--------------------------------------|
| Method | Analog resistance film type |
| Switch Resolution | 1024 (W) × 1024 (H) |
| Mechanical Life | One million activations or more |
| Surface Treatment | Hard-coated, anti-glare treatment 5% |

Function Switch Specifications

| Item | Specifications |
|--------------------|---------------------------------|
| Number of Switches | 6 |
| Method | Digital resistance film |
| Mechanical Life | One million activations or more |

Interface Specifications

| Item | Specifications |
|---|--|
| Serial Interface for PLC Connection (D-sub 25-pin, female) | RS-232C, RS-422/485 Asynchronous type Data length: 7, 8 bits Parity: Even, odd, none Stop bit: 1, 2 bits Baud rate: 4800, 9600, 19200, 38400, 57600 bps |
| Serial Interface 1 for Screen Data Transfer/External Connection (Modular jack, 8-pin) | RS-232C, RS-422/485 (2-wire connection) CREC, Barcode, V-I/O, Multi-link 2, Temperature control network/PLC2Way, V-link, etc. |

Clock and Backup Memory Specifications

| Item | Specifications |
|--------------------------------|--|
| Battery Specification | Coin-type lithium primary cell |
| Backup Memory | SRAM 128 kbyte |
| Backup Time Period | 5 years (ambient temperature at 25°C) |
| Battery Voltage Drop Detection | Provided (internal memory allocated) |
| Calendar Accuracy | Monthly deviation ± 90 sec (ambient temperature at 25°C) |

Drawing Environment

| Item | Specifications |
|----------------|---|
| Drawing Method | Exclusive configuration software |
| Drawing Tool | Name of exclusive configuration software: V-SFT (Ver. 2.2.1.0 and later) Personal computer: Pentium II 450 MHz or above recommended OS: Windows98/Me/NT Ver.4.0/2000/XP Capacity of hard disk required: Free space of approx. 460 Mbyte or more (For minimum installation: approx. 105 Mbyte) Display: Resolution 800 × 600 or above recommended |

Display Function Specifications

| Item | | Specifications | | | | |
|----------------------------------|---|--------------------------|------------------------|-----------------------|----------------------|------------------------|
| Display Language* | | Japanese | English/Western Europe | Chinese (traditional) | Chinese (simplified) | Korean |
| Characters | 1/4-size, 1-byte | ANK code | Latin1 | ASCII code | ASCII code | ASCII code |
| | 2-byte 16-dot | JIS #1, 2 levels | – | Chinese (traditional) | Chinese (simplified) | Hangul (without Kanji) |
| | 2-byte 32-dot | JIS #1 level | – | – | – | – |
| Character Size | 1/4-size: 8 × 8 dots 1-byte: 8 × 16 dots 2-byte: 16 × 16 dots or 32 × 32 dots Enlarge: W: 1 to 8 times, H: 1 to 8 times | | | | | |
| Number of Displayable Characters | 1/4-size | 40 characters × 30 lines | | | | |
| | 1-byte | 40 characters × 15 lines | | | | |
| | 2-byte | 20 characters × 15 lines | | | | |
| Characters Properties | Display properties: Normal, reverse, blink, bold, shadow Colors: V606eC: 16 color + blink, V606eM: Monochrome 8-grade + blink | | | | | |
| Graphics | Lines: Line, continuous line, box, parallelogram, polygon Circles: Circle, arc, sector, ellipse, elliptical arc Others: Tile patterns | | | | | |
| Graphic Properties | Line types: 6 (thin, thick, dot, chain, broken, two-dot chain) Tile patterns: 16 (incl. user-definable 8 patterns) Display properties: Normal, reverse, blink Colors: V606eC: 16 color + blink, V606eM: Monochrome 8-grade + blink Color selection: Foreground, background, boundary (line) | | | | | |

* In addition, the following fonts are available. For more information, refer to the Reference Manual (Operation) and the V-SFT Additional Specifications Manual.
 Gothic, English/Western Europe HK Gothic, English/Western Europe HK Times, Central Europe, Cyrillic, Greek, Turkish

Function Performance Specifications

| Item | | Specifications |
|---|------------------------|---|
| Screens | | Max. 1024 |
| Screen Memory | | Flash memory: Approx. 760 kbyte (varies depending on the font) |
| Switch | | 192 per screen |
| Switch Actions | | Set, reset, momentary, alternate, to light (Possible to press a function switch and a switch on the display at the same time) |
| Lamps | | Reverse, blink, exchange of graphics 192 per screen |
| Graphs | | Pie, bar, panel meter and closed area graph: No limitation within 128 kbyte per screen ^{*1} Statistics and trend graphs: Max. 256 per layer ^{*2} |
| Data Setting | Numerical Data Display | No limitation within 128 kbyte per screen ^{*1} |
| | Character Display | No limitation within 128 kbyte per screen ^{*1} |
| | Message Display | Resolution: Max. 40 characters (1-byte) No limitation within 128 kbyte per screen ^{*1} |
| Sampling | | Sampling display of buffer data (Constant sample, bit synchronize, bit sample, relay sample, alarm function) |
| Graphic Library | | Max. 2560 |
| Multi-Overlaps | | Max. 1024 |
| Data Blocks | | Max. 1024 |
| Messages | | Max. 6144 lines |
| Patterns | | Max. 1024 |
| Macro Blocks | | Max. 1024 |
| Page Blocks | | Max. 1024 |
| Direct Blocks | | Max. 1024 |
| Screen Blocks | | Max. 1024 |
| Screen Library | | Max. 1024 |
| Temperature Control Network/PLC2Way Table | | Max. 32 |
| Time Display | | Time display function: provided |
| Buzzer | | Buzzer: provided, 2 sounds (short beep, long beep) |
| Auto OFF Function | | Always ON, random setting |
| Self-diagnostic Function | | Switch self-test function Communication parameter setting check function Communication check function |

*1 The number of setting memory locations is limited to 256 per screen.

*2 Layer: 4 per screen (base + 3 overlaps)

2. Dimensions and Panel Cut-out

(Unit: mm)

- Side View

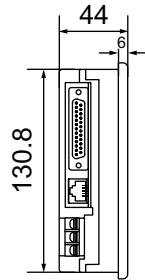

- Front View

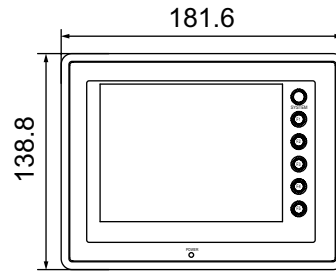

- Rear View

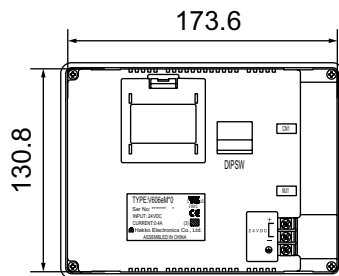

- Bottom View

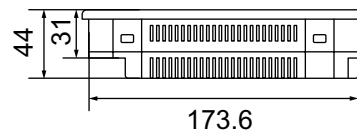

- Panel Cut-out Dimensions

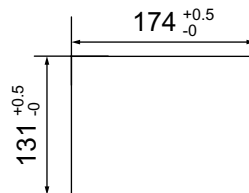

3. Names and Functions of Components

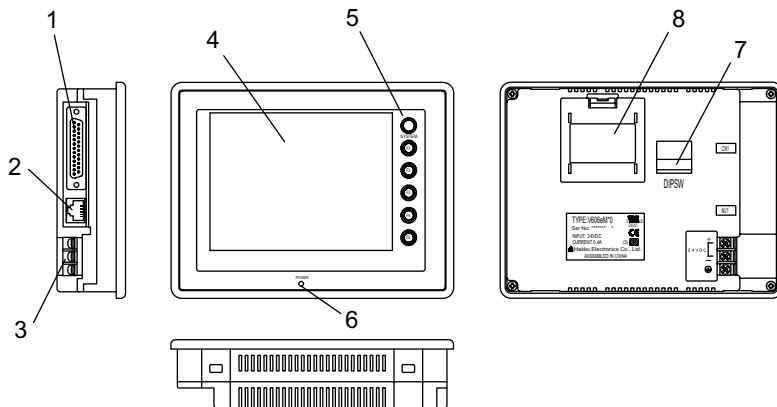

1. PLC communication connector (CN1)
Used for connection between the V606e and a PLC or an external control unit (computer, custom controller, etc).
2. Modular jack connectors (MJ1)
Used for screen data transfer and connection with temperature controller, barcode reader, CREC, etc.
3. Power supply terminal block
Supplies the power to the V606e (24 VDC)
4. Display
This is the display unit.
5. Function switches
Used for RUN /STOP selection, contrast adjustment, and backlight ON/OFF (according to the setting).
These switches can be used as user switches in the RUN mode.
6. Power lamp (POWER)
Illuminates (green) when the power is supplied to the unit.
7. DIP switch
Used for setting terminating resistance of the CN1 signal line and the MJ1 RS-422/485 signal line.
8. Battery holder (V606eX20 only)
Contains a backup battery for SRAM and clock.
When the battery voltage drops, replace the battery with a new one (V7-BT).

4. Serial Connector (CN1)

Serial Connector for PLC Connection

To communicate with the PLC (RS-232C, RS-422/485), connect the cable to the serial connector (CN1) at the side of the V606e unit.

Side View

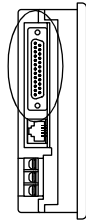

The serial connector pins correspond to signals as given below.

| CN1 (D-sub 25-pin, female) | Pin No. | Signal Name | Contents |
|----------------------------|---------|-------------|----------------------------|
| | 1 | FG | Frame ground |
| | 2 | SD | RS-232C send data |
| | 3 | RD | RS-232C receive data |
| | 4 | RS | RS-232C RS request to send |
| | 5 | CS | RS-232C CS clear to send |
| | 6 | | Not used |
| | 7 | SG | Signal ground |
| | 8 | | Not used |
| | 9 | +5 V | Use prohibited |
| | 10 | 0 V | Use prohibited |
| | 11 | | Not used |
| | 12 | +SD | RS-422 send data (+) |
| | 13 | -SD | RS-422 send data (-) |
| | 14 | +RS | RS-422 RS send data (+) |
| | 15 | | Not used |
| | 16 | | Not used |
| | 17 | -RS | RS-422 RS send data (-) |
| | 18 | -CS | RS-422 CS receive data (-) |
| | 19 | +CS | RS-422 CS receive data (+) |
| | 20 | | Not used |
| | 21 | | Not used |
| | 22 | | Not used |
| | 23 | | Not used |
| | 24 | +RD | RS-422 receive data (+) |
| | 25 | -RD | RS-422 receive data (-) |

The following connector is recommended.

| | | |
|-----------------------|-----------------------------|--|
| Recommended connector | DDK-make 17JE23250-02 (D8A) | D-sub 25-pin, male, metric thread, with hood |
|-----------------------|-----------------------------|--|

5. Modular Jack (MJ1)

This is a modular connector used for connection for screen data transfer, temperature controller, barcode reader, card recorder (CREC) or serial extension I/O (V-I/O).

Side View

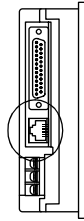

Pins of modular jack 1 correspond to signals as given below.

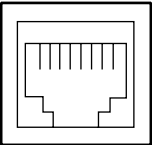
| MJ1/2 | Pin No. | Signal Name | Contents |
|---|---------|-------------|--|
|  | 1 | +SD/RD | RS-485 + data |
| | 2 | -SD/RD | RS-485 - data |
| | 3 | +5 V | Externally supplied +5 V MAX 150 mA |
| | 4 | +5 V | |
| | 5 | SG | Signal ground |
| | 6 | SG | |
| | 7 | RD | RS-232C receive data |
| | 8 | SD | RS-232C send data |

V-SFT Setting

- The use of modular jack 1 can be set on the V-SFT editor.
- Select [Modular] from the [System Setting] menu. The [Modular Jack] dialog is displayed. Select the use of modular jack 1 from the following options.

Modular Jack 1
 [Editor Port]^{*1}
 [Card Recorder]^{*2}
 [Barcode]^{*3}
 [V-I/O]^{*4}
 [Multi-Link]^{*5}
 [Temp./PLC2Way]^{*6}
 [V-Link]^{*7}
 [Ladder Tool]^{*8}
 [Modbus Slave]^{*9}
 [Printer (Serial Port)]^{*10}

*1 Refer to the next section "Transferring Screen Data".

*2 Select this option when connecting the card recorder (CREC).

*3 Refer to the next section "Barcode Reader Connection".

*4 Select this option when connecting the serial extension I/O (V-I/O).

*5 Select this option when "Multi-link 2" is selected for [Connection] and "1" is set for [Local Port] on the [Comm. Parameter] dialog.

*6 Select this option when connecting the temperature controller network or PLC2Way.

*7 Select this option for V-Link connection.

*8 Select this option when using the ladder transfer function.

*9 Select this option for Modbus slave connection.

*10 Select this option when connecting the printer with serial interface.
 Refer to page 2-11.

Transferring Screen Data

- Use modular jack 1 (MJ1) when transferring screen data.
- When [Editor Port] is selected for [Modular Jack 1] on the V-SFT editor, it is possible to transfer data in the RUN mode because the RUN/STOP mode (on the Main Menu screen) can be automatically selected.
Also RUN/STOP mode is automatically selected for on-line editing and simulation.
- When an option other than [Editor Port] is selected for [Modular Jack 1], select the STOP mode (on the Main Menu screen) and transfer screen data. Simulation or on-line editing is not available.
- When transferring screen data, use Hakko Electronics' data transfer cable (V6-CP) 3 m to connect the V606e to a personal computer.

Barcode Reader Connection

- It is possible to receive the signal from a barcode reader by connecting the barcode reader at the modular jack (MJ1) of the V606e.
- To connect a barcode reader to the modular jack (MJ1), use Hakko Electronics' optional cable (V6-BCD).
Length: 3 m
with modular plug
- Notes on connection
 - In the case of barcode readers with CTS and RTS control, it may be necessary to install a jumper between RTS and CTS. Otherwise the barcode reader may not work correctly.
 - The external power supply (+5 V) is max. 150 mA. (Refer to page 2-9.)
- When using the barcode reader that was connected to V4S (MONITOUCH's old version), connect it to the D-sub 9-pin female connector using the V6-BCD cable as shown below.

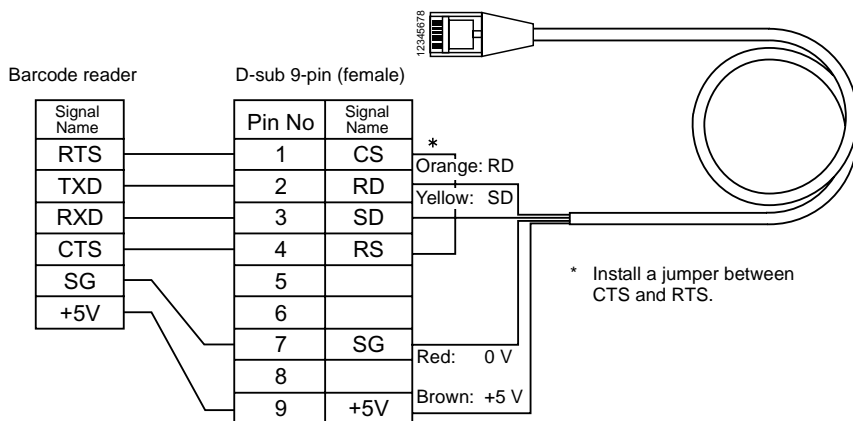
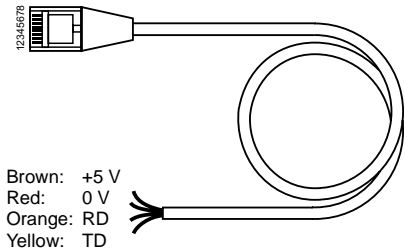

Connection with Printer through Serial Interface

- To connect a printer through serial interface, connect the cable to a modular jack (MJ1).
- Refer to the specification sheet of the printer to be used for the connecting cable for serial interface.
For information on MJ1 signals, refer to page 2-9.
- To connect a printer through the parallel interface, use a commercially available parallel-serial converter.
When the serial connector of the converter is a D-sub 9-pin male connector, use Hakko Electronics' V6-CP connection cable.

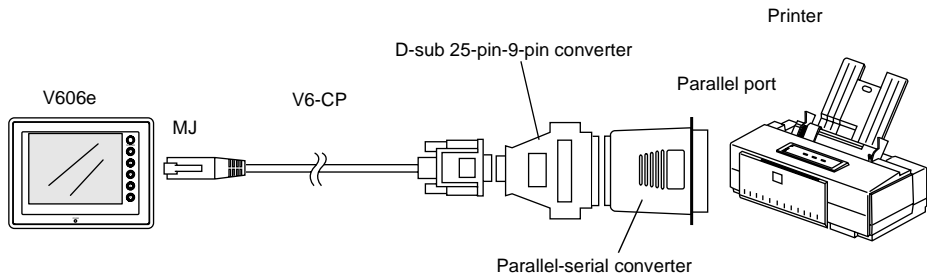

Compatible Printer Models

Control code system:

- PR201
- ESC-P
- HP

PC-PR201 series compatible with MS-DOS computer
ESC/P24-J84, ESC/P-J84, ESC/P super function compatible
with MS-DOS computer
PCL Level 3

Others:

- CBM292/293
- MR400

CBM's line thermal printer (Screen hard copying is not possible.)

Sato's barcode printer "MR400 series" (It is not possible to print a screen hard copy, data sheet or sampling data.)

MEMO

Please use this page freely.

3 Installation

1. Mounting Procedure
2. Power Supply Cable Connection

1. Mounting Procedure

Mounting Procedure

1. Cut out the mounting panel (max. thick: 5 mm) to match the dimensions shown below.

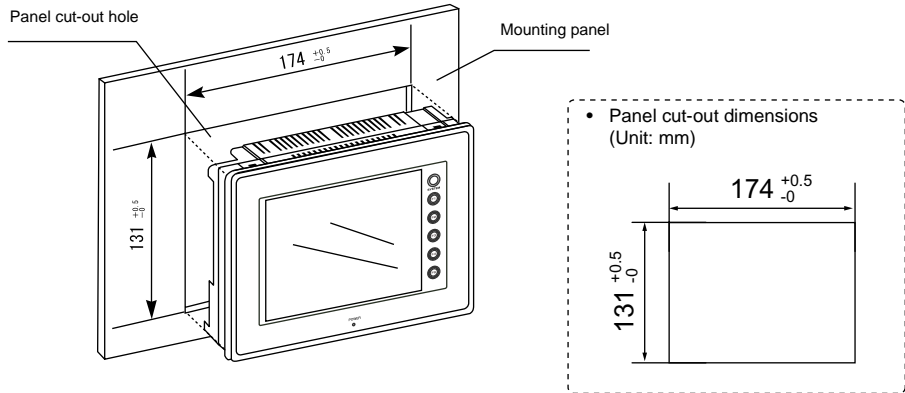

2. Insert four fixtures attached to the V606e into the mounting holes, and tighten them with the locking screws.
<Tightening torque: 0.3 to 0.5 N•m>

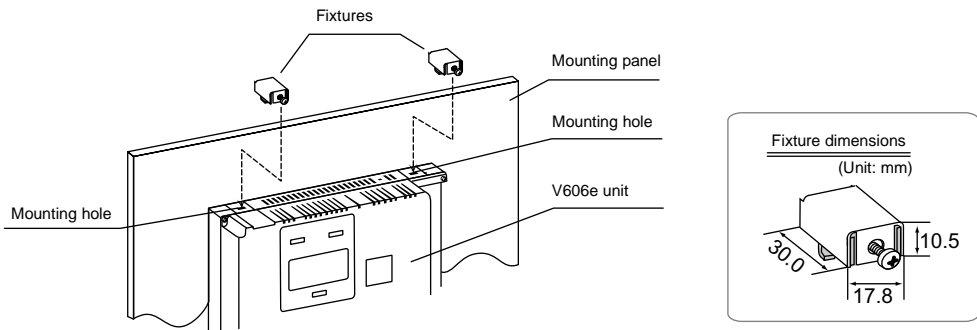

3. Mount the gasket so that it will be sandwiched securely between the unit and the mounting panel.

Mounting Angle

Install the unit within the angle of 0° to 135° as shown on the right.

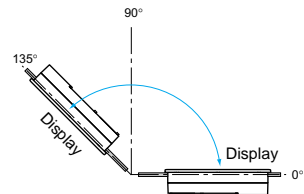

2. Power Supply Cable Connection



Electric shock hazard
Shut the power off before connecting the power supply cable.

Power Supply Cable Connection

- Connect the power supply cable to the terminal on the backside of the unit.

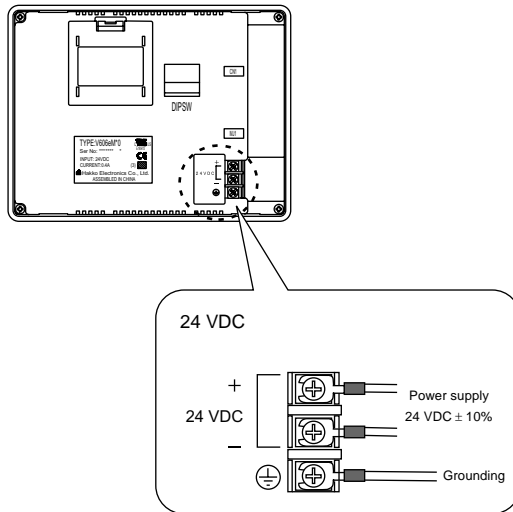

- When connecting the power supply cable, tighten the terminal screws to the following torque.

| Screw Size | Tightening Torque | Crimp-style Terminal (Unit: mm) |
|------------|-------------------|---------------------------------|
| M3.5 | 0.5 N•m | 7.1 MAX 7.1 MAX |

- The power source must be within the allowable voltage fluctuation.
- Use a power source with low noise between the cables or between the ground and the cable.
- Use as thick a power supply cable as possible to minimize drop in voltage.
- Keep the power supply cable a sufficient distance from high-voltage, large-current carrying cables.
- Be sure to attach the terminal cover to the terminal block.

Grounding



Be sure to establish a ground of MONITOUCH.
(The level of grounding resistance should be less than 100 Ω.)

- An independent earth pole must be used for MONITOUCH.
- Use a cable which has a nominal cross section of more than 2 mm² for grounding.
- Set the grounding point near the MONITOUCH to shorten the distance of grounding cables.

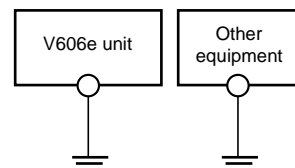

4 Instructions

1. Coin-type Lithium Battery (V606eX20 only)
2. DIP Switch Setting
3. Function Switches

1. Coin-type Lithium Battery (V606eX20 only)

CAUTION

The MONITOUCH is delivered without inserting the battery connector in the battery holder on the back of the unit.
 Be sure to set the battery when using the calendar function or SRAM.
 Without battery, the contents in the SRAM or calendar will not be retained.

Battery Mounting Procedure

DANGER

Electric shock hazard
 Steps 2 to 5 must be performed when the power to the V606e unit is turned off.

1. Turn the unit off.
2. Open the battery holder cover.

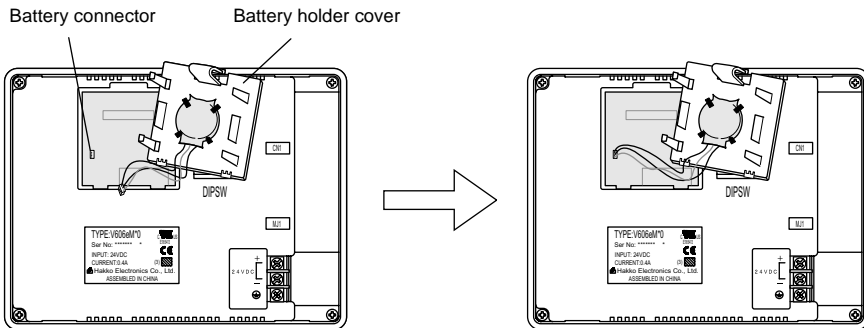

3. Check that the battery is securely attached to the backside of the cover, and connect the battery connector.
4. Close the battery holder cover.
5. Enter a date five years from now for "Battery replacement" on the sticker on the battery holder.

* The battery status is output to the internal memory \$s167 of the V606e.
 If the battery voltage drops before five years has elapsed, replace the battery immediately.

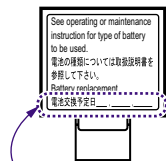

Enter a date five years from now

| | MSB | 15 | 14 | 13 | 12 | 11 | 10 | 09 | 08 | 07 | 06 | 05 | 04 | 03 | 02 | 01 | 00 | LSB |
|--------|-----|----|----|----|----|----|----|----|----|----|----|----|----|----|----|----|----|-----|
| \$s167 | | 0 | 0 | 0 | 0 | 0 | 0 | 0 | 0 | 0 | 0 | | | 0 | 0 | 0 | 0 | |

System reserved (setting: 0)

System reserved (setting: 0)

- 0: Battery OK
- 1: Battery voltage drop or no battery

6. Turn on the power to the V606e unit.

If the battery is not connected, the message "Data has some error. Error: 161 (24:)" is displayed on the Main Menu screen or "Format required." is displayed on the "SRAM/Clock Adjust." screen.

"SRAM/Clock Adjust." screen

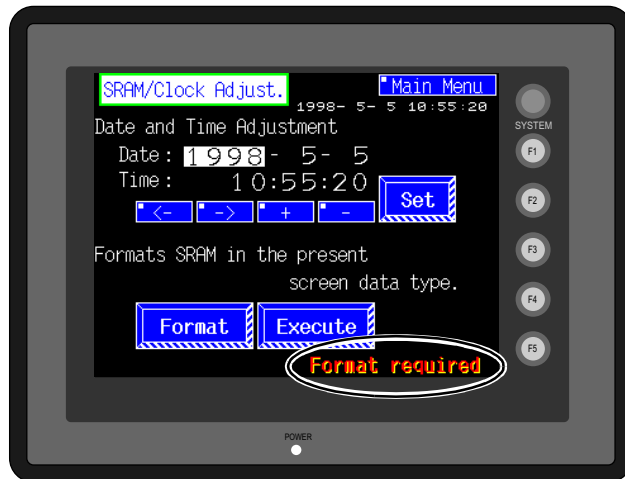

Battery Replacement

Safety Instructions on Handling the Battery

Lithium batteries contain combustible material such as lithium or organic solvent. Mishandling may cause heat, explosion or ignition resulting in fire or injury. To prevent accidents, pay attention to the following cautions when handling the lithium battery.

CAUTION

- Be sure to discharge static electricity from your body before battery replacement.
- Use the battery "V7-BT" (replacement battery) for replacement.
- Rough handling of the battery may cause a fire or chemical burn hazard.
- Do not disassemble, incinerate or heat the battery.
- Observe the local and governmental regulations when disposing of waste batteries.
- Keep batteries out of reach of children (If swallowed, immediately consult a doctor.)
- Never re-charge the battery.
- When the battery leaks or smells, the leaking battery electrolyte may catch a fire. Keep from heat or flame.

Battery Replacement Procedure

Replacement batteries are available from Hakko Electronics.

| Name | Type | Contents |
|-----------------------------------|-------|--|
| Replacement battery for the V606e | V7-BT | <ul style="list-style-type: none"> Coin-type lithium primary cell 1 pce Cautions sticker 1 pce |

- Replace the battery "V7-BT" within three minutes after the unit is turned off. If it is not possible to replace within three minutes, use the V-SFT editor (cable: V6-CP) or a CF card and make a backup copy of data in the SRAM.
 - Start the V-SFT editor.
 - Click the [Transfer] icon. The [Transfer] dialog is displayed.
 - Select [Display] for [Transfer Device] and [SRAM Data] for [Transfer Data].
 - Click the [PC <-] under [Transfer].
 - Save the read data in the "*.RAM" file.
- Turn the unit off. Open the battery holder slowly. A battery set in the socket will come into view.
- Unplug the battery connector, and remove the battery from the socket. Take out the battery while pressing the center of the battery holder cover as shown in the figure at right.

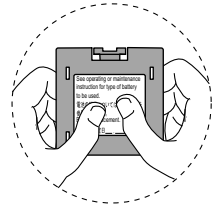

- Set a new battery. Fit the battery into the socket in such a manner that the red cable side of the battery faces the board and the cable branches from the bottom. Insert the battery in the "b" side first, and push it down to "b" while inserted in the "a" side.

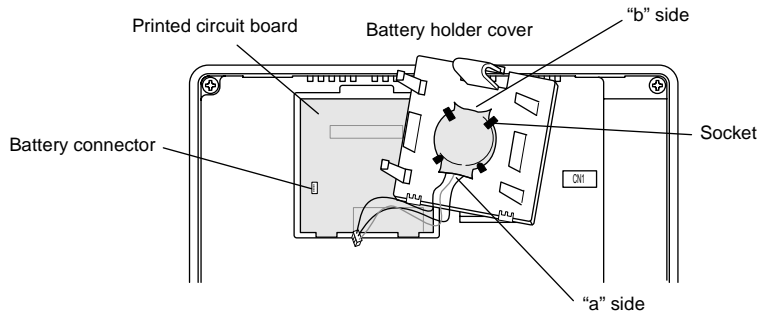

- Plug in the battery connector and close the battery holder cover.
- Remove the existing caution sticker. Enter a date five years from now for "Battery replacement" on the new caution sticker, and attach it to the backside of the unit.
- When the backup copy of the SRAM data has been saved in step 1, turn on the unit and load the data to the unit.

2. DIP Switch Setting

DIP Switch (DIPSW) Setting

Set the terminating resistance for RS-422/485 connection with the DIP switch.
When setting the DIP switch, turn the power off.

Rear View

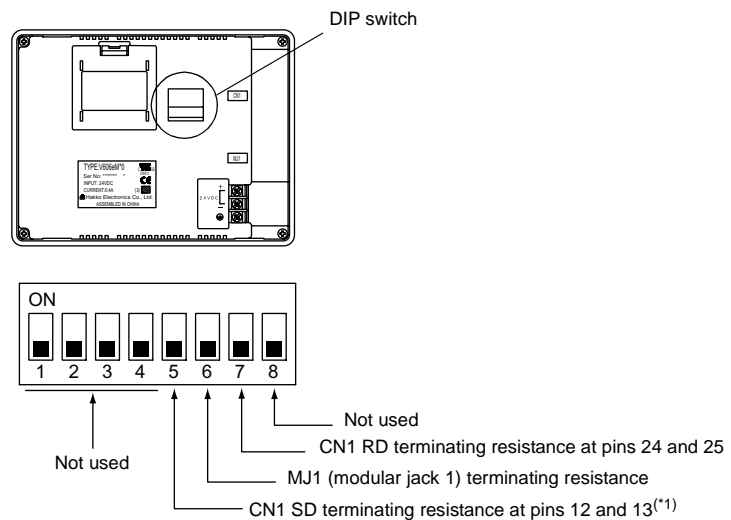

* Set DIPSW1 to 4 and DIPSW8 (not used) to the OFF position.

Terminating Resistance Setting (DIPSW5, 6, 7)

- When connecting the PLC at CN1 via RS-422/485 interface (2-wire connection), set DIPSW7 to the ON position.
- When connecting the PLC at CN1 via RS-422/485 interface (4-wire connection), set DIPSW5 and 7 to the ON position.
- For the following connections at modular jack 1, set DIPSW6 to the ON position.
 - Master station for multi-link 2 connection
 - Temperature controller network/PLC2Way connection via RS-485
 - Card Recorder: Connection with the CREC (optional)
 - Serial extension I/O: Connection with the V-I/O (optional)
 - Connection to the V606e at the termination of V-link connection via RS-485

3. Function Switches

Types

- There are six function switches provided.
[SYSTEM], [F1], [F2], [F3], [F4], [F5]

[SYSTEM] Switch

The [SYSTEM] switch works in “alternate” operations. When this switch is pressed once, the switch menu is displayed at the side of the function switches [F1] to [F5], and each function switch corresponds to the menu item displayed in the switch menu. When the [SYSTEM] switch is pressed again, the switch menu disappears, and the function switches [F1] to [F5] work as defined by the user. (page 4-5)

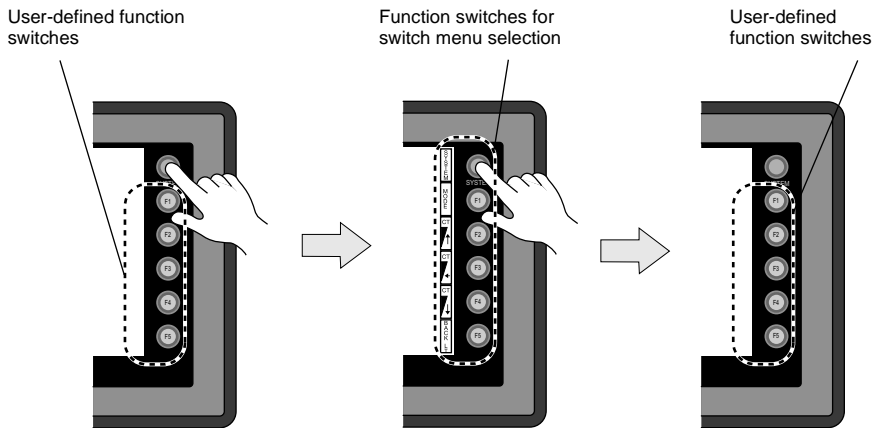

User-defined Function Switches [F1] to [F5]

- When the V606e is in the STOP mode, the function switches do not work.
- When the V606e is in the RUN mode and the switch menu by the [SYSTEM] switch is not displayed, the function switches can be defined by the user.
- User-defined function switches should be set in the following dialogs of the V-SFT editor.
 - Settings for each screen
[Edit] → [Local Function Switch Setting] → [Function Switch Setting] dialog
 - Setting for all screens
[System Setting] → [Function Switch Setting] → [Function Switch Setting] dialog

5 Connections

1. 1 : 1 Connection
2. 1 : n Connection (Multi-drop)
3. n : 1 Connection (Multi-link 2)
4. n : 1 Connection (Multi-link)
5. Universal Serial Communications
6. V-Link
7. PLC2Way
8. Temperature Control Network

1. 1 : 1 Connection

- One set of the V606e is connected to one PLC (1 : 1 connection).

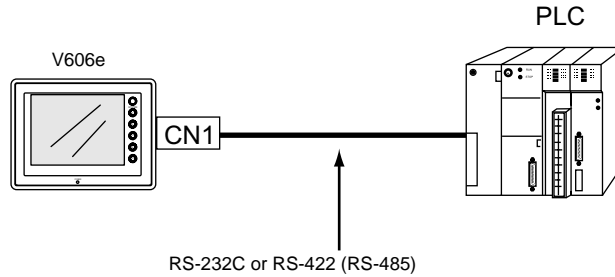

- The host link unit of the PLC or the CPU port is used and the V606e (master station) establishes communications according to the protocol of the PLC. Consequently, it is not necessary to have the dedicated communication program on the PLC (slave station). The V606e reads the PLC memory for screen display. It is also possible to write switch data or numerical data entered through the keypad directly to the PLC memory.

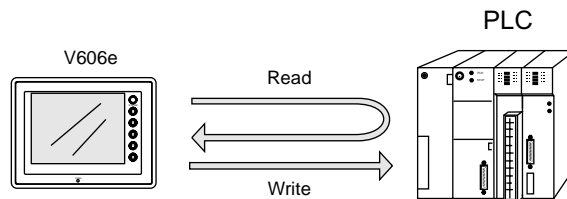

- For more information on wiring and communication settings, refer to the PLC Connection Manual.

2. 1 : n Connection (Multi-drop)

One V606e is connected to multiple PLCs. (Maximum connectable PLCs: 31)

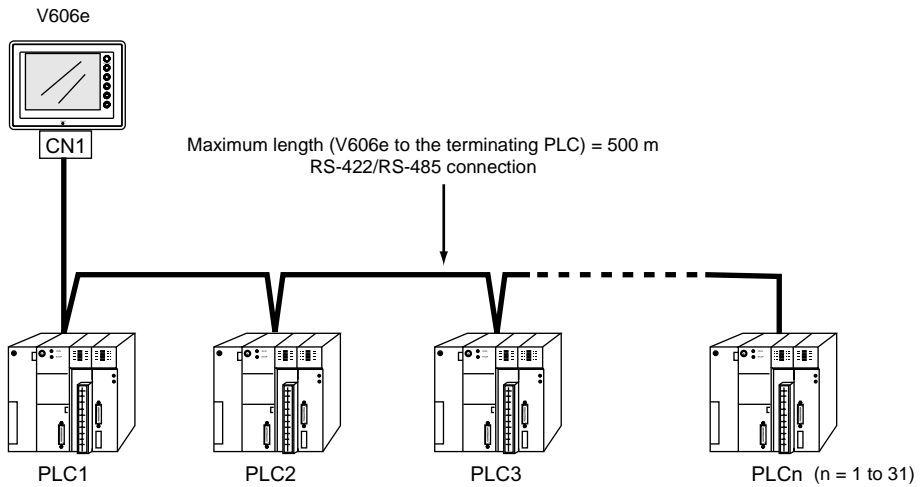

- For more information on wiring and communication settings, refer to the PLC Connection Manual.

3. n : 1 Connection (Multi-link 2)

- One PLC is connected to a maximum of four V606e units.
- An original network is created where the V606e (Local Port 1) that is directly connected to the PLC is the master station, and other three V606e units are slave stations. Only the master station makes communications directly with the PLC, and the slave stations make communications with the PLC via the master station.

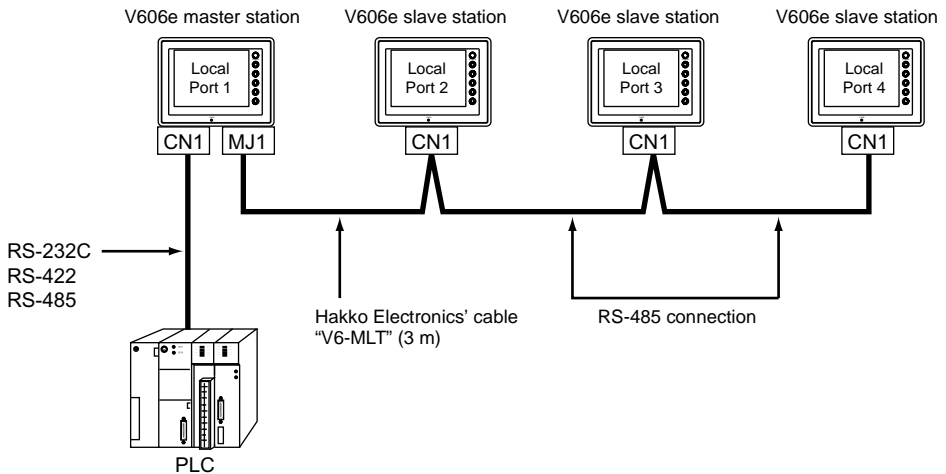

- Communications between the V606e master station and the PLC depend on the communication speed set on the PLC. The maximum available speed for the V606e is 57600 bps, which is higher than the one available with multi-link connection described in "4. n : 1 Connection (Multi-link)."
- This multi-link connection is available with almost all the PLC models that support 1 : 1 connection (refer to the Appendix).
(The connection between the master station and the PLC is the same as the one for 1 : 1 connection.)
- Use the RS-485 2-wire connection between stations of the V606e. Please use Hakko Electronics' multi-link 2 master cable (V6-MLT) for connection between the master station (Local Port 1) and the slave station (Local Port 2).
- The V606e and V6 series can be used together. The V6 series can be the master station. (However, when V606e/V606/V606i is the master station, the slave station must be V606e/V606/V606i. Also, depending on the hardware version of the V6 series, multi-link 2 connection may not be supported. Refer to the V6 Hardware Specifications.)
- For more information on wiring and communication settings, refer to the PLC Connection Manual.

4. n : 1 Connection (Multi-link)

- One PLC is connected to multiple V606e units. (Maximum connectable units: 31)

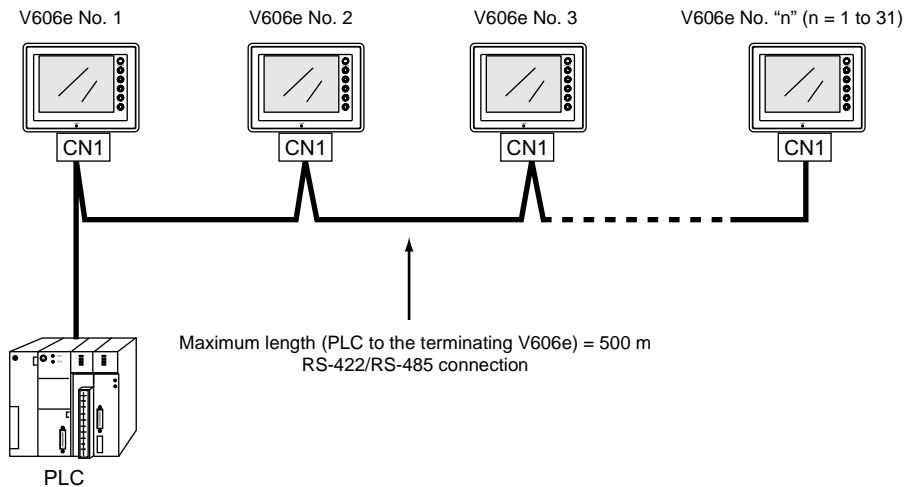

- The PLC must be of the type of signal level RS-422/RS485 with station numbers. RS-422 connection between the V606e ↔ PLC must be in 2-wire connection.
- The V606e and V6 series can be used together.
- For more information on wiring and communication settings, refer to the PLC Connection Manual.

5. Universal Serial Communications

- A general purpose computer or an ASCII unit of the PLC (master station) controls the V606e (slave station) using dedicated commands.

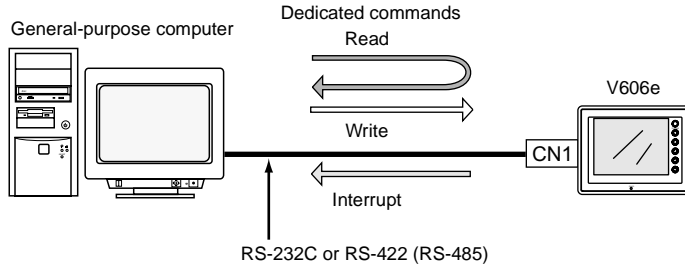

- The V606e internal user memory addresses (\$u) must be used for memory allocation for switch, lamp or data display parts.
When the master station specifies a screen number, data is written to the internal memory address (\$u) allocated for the screen. If the screen is switched internally, the new screen number is read and is written to the internal memory address (\$u) allocated for the screen.
- For 1 : 1 connection, the V606e can send an interrupt to the master station through switch activation, write command from the keypad, and screen change.
- Use CN1 of the V606e for connection with a general-purpose computer. Either signal level RS-232C or RS-422 (RS-485) can be selected.
- In addition to 1 : 1 connection, 1 : n connection is available between the general-purpose computer and the V606e via RS-422.
(A maximum of 32 V606e units can be connected.)
For 1 : n connection, interrupts cannot be used.

General-purpose computer

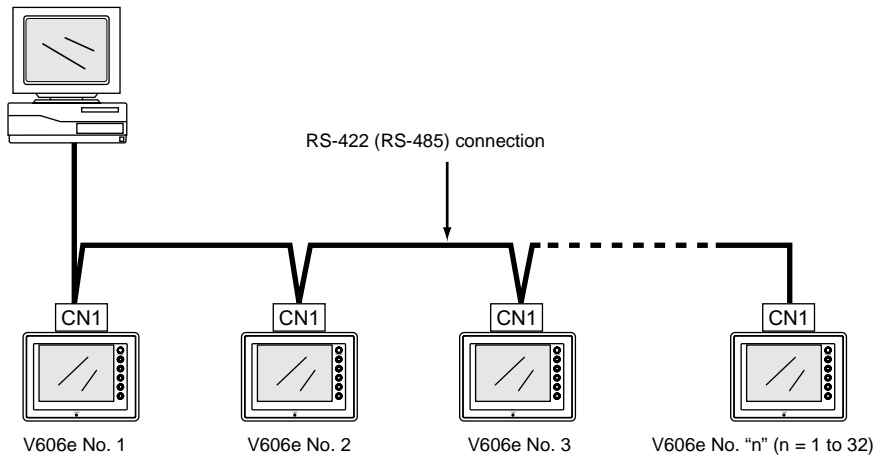

- For more information, refer to the PLC Connection Manual.

6. V-Link

- "V-Link" is the network where the computer reads from and writes to the internal memory of the V606e, memory card, PLC memory or temperature control/PLC2 memory using a dedicated protocol.

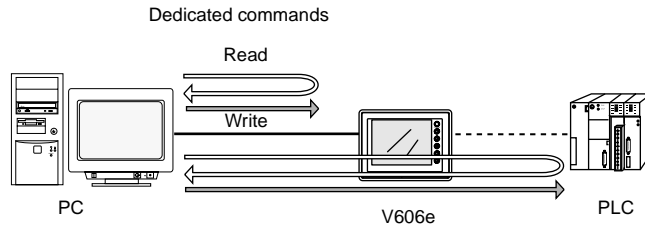

- Use the MJ port of the V606e for connection with a general-purpose computer. Use CN1 for communications with the PLC. Data of the PLC can be collected through communications with the V606e. Data collection is available even between the products of different manufacturers.
- Either signal level RS-232C or RS-485 can be selected.
With RS-232C, one V606e unit can be connected; with RS-485, a maximum of 31 V606e units can be connected.

<RS-485 connection>

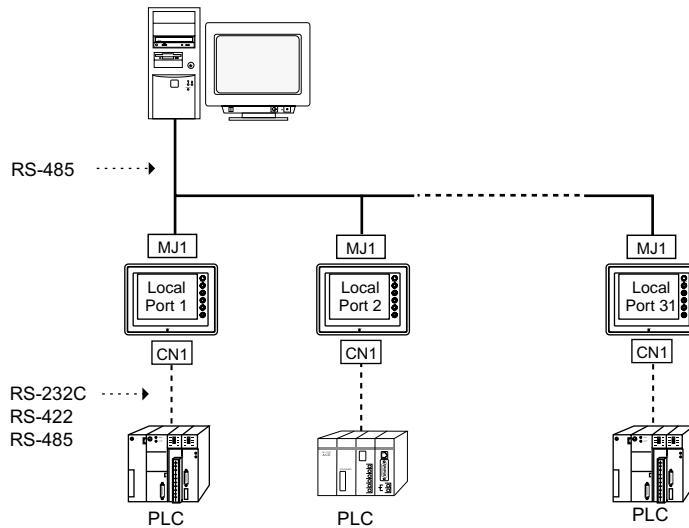

- For more information, refer to the PLC Connection Manual.

7. PLC2Way

- The “PLC2Way” function is an original network function where one V606e unit can be connected to two PLCs. Even if the manufacturers of these PLCs are not the same, they can be connected to one V606e unit.

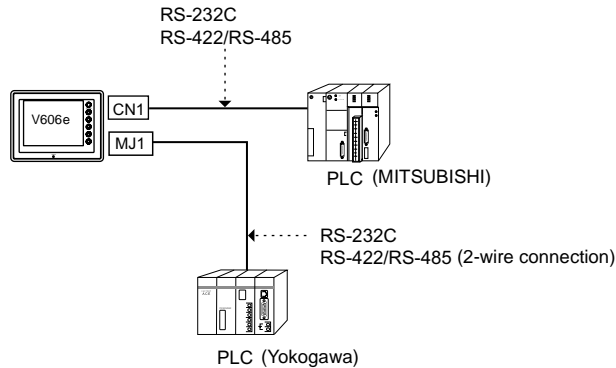

- Connect one PLC to the CN1 connector, and the second PLC to the MJ port.
- With the PLC2Way function, it is possible to communicate with PLCs without special program in the same way as 1 : 1 connection.
Two PLCs that are connected to the V606e are controlled at the same time, and memory read/write operations are available with these two PLCs.
- Connection at the MJ port can be performed via RS-232C or RS-485 (2-wire).
With RS-232C, one PLC can be connected; with RS-485, a maximum of 31 PLCs can be connected.

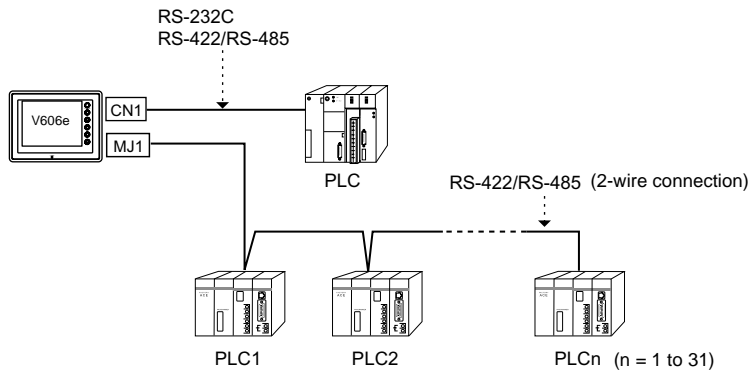

- Constant reading/sampling of PLC data connected to the MJ port
When read/write memory addresses are preset on the temperature control network/PLC2Way table, background data reading is performed at regular intervals. It is also possible to save the read data in the V606e internal buffer, SRAM or CF card.
- Data transfer between PLCs
The PLC memory data can be transferred to another PLC in blocks using a macro command.
- For more information, refer to the PLC Connection Manual.

8. Temperature Control Network

- Using the temperature control network, the V606e can be connected to the temperature controller or inverter.
- With RS-232C, one PLC can be connected; with RS-485, a maximum of 31 temperature controllers can be connected.

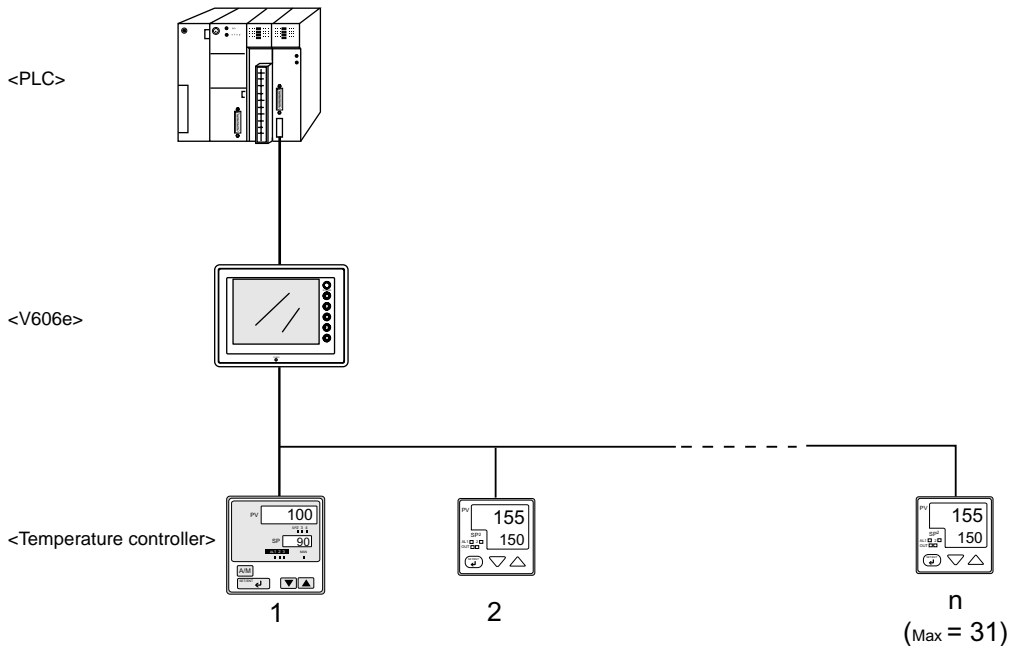

- Data of temperature controllers connected to the V606e can be set or monitored.
- Periodical reading/sampling of temperature controller data
When read/write memory addresses are preset on the temperature control network/PLC2Way table, background data reading is performed at regular intervals. It is also possible to save the read data in the V606e internal buffer, SRAM or CF card.
- Data transfer
It is also possible to transfer data in the PLC memory, V606e internal memory or a memory card to the temperature controller at one time using a macro command. Conversely, data in the temperature controller can be transferred to the PLC memory, V606e internal memory or a memory card at one time.
- For more information, see the Temperature Control Network Manual.

6 **MONITOUCH** **Operations**

1. Operational Procedures
2. Main Menu Screen

1. Operational Procedures

MONITOUCH Operation

Follow the procedure below to operate the MONITOUCH.

1. Installation and wiring
For more information, refer to "Chapter 3."
2. Connection with devices including a PLC and a temperature controller
For instructions and precautions on wiring between the MONITOUCH and other devices, refer to the separate PLC Connection Manual or Temperature Control Network Manual.
3. MONITOUCH power-on
 - New MONITOUCH

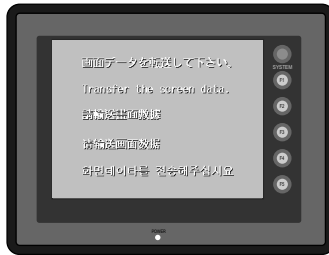

- Other than the above
When the check screen below and then the next user screen are displayed correctly, go to step 5.



4. Screen data creation and transfer
 - New MONITOUCH
"Initial Screen" (page 6-2)
 - Other than the above
Refer to Chapter 5, "Data Transference" in the Reference Manual (Operation).
5. Operation start
The MONITOUCH becomes operable with a PLC or a computer connected to it.
 - * If the MONITOUCH does not operate normally and shows an error message, eliminate the cause by referring to "Chapter 7."

Initial Screen

When the power of MONITOUCH is turned on for the first time, the Main Menu screen shown below on the left is displayed.

Initial screen displayed when power is turned on for the first time

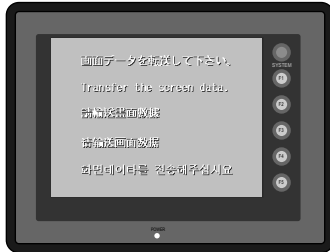

Main Menu screen after transferring screen data

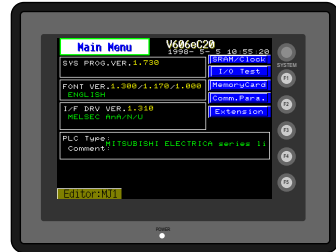

Transferring Screen Data for the First Time

A V6-CP cable is necessary when transferring screen data to MONITOUCH for the first time. Transfer screen data from the computer while the initial screen is displayed.

2. Main Menu Screen

The Main Menu screen is displayed when the MONITOUCH is in the STOP mode. In this state, the MONITOUCH is disconnected from the PLC and other external devices.

Displaying the Main Menu Screen

In the RUN Mode

To bring up the Main Menu screen in the RUN mode, press the [SYSTEM] switch and then the [F1] switch while the vertical menu is displayed.

(Hold down the [F1] switch for the required time if [Change-over Time] has been set.)

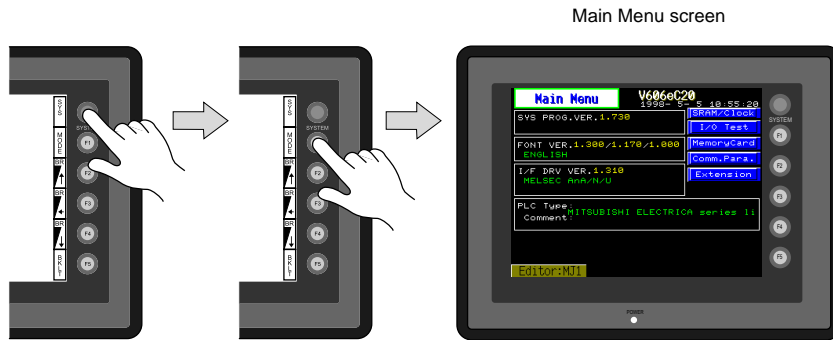

When the [SYSTEM] switch is disabled:

Pressing the [SYSTEM] switch does not bring up the vertical menu.

In this case, press the [SYSTEM] and [F5] switches at the same time. (If the time for simultaneous pressing of these switches is preset, hold down the switches for the required time.)

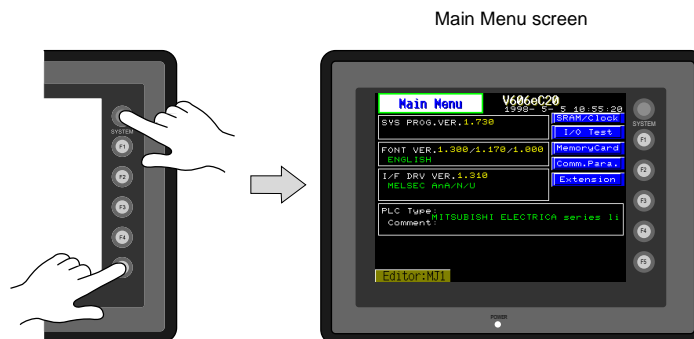

When the [MODE] (F1) switch is disabled:

When the vertical menu is displayed by the [SYSTEM] switch, the [MODE] (F1) switch does not work. In this case, press the [MODE] (F1) and [F5] switches at the same time. (If the time for simultaneous pressing of these switches is preset, hold down the switches for the required time.)

Moving Back to the Screen in the RUN Mode

Press the [SYSTEM] switch and the [F1] switch.

Main Menu Screen

- The Main Menu screen indicates the V606e model, system information, and screen data information.
- The Main Menu screen is the system menu screen for transferring screen data between a personal computer and the V606e.
When transferring screen data from a personal computer to the V606e, this Main Menu screen must be displayed. (However, if [Editor Port] is selected for [Modular Jack 1] or on-line editing is used, it is not necessary to bring up this screen.)

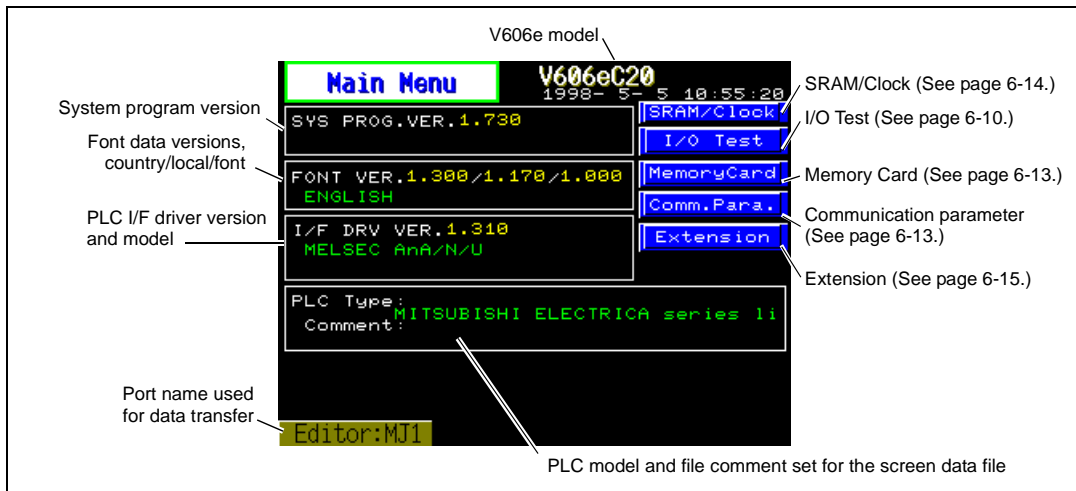

1. I/O Test

When the [I/O Test] switch on the Main Menu screen is pressed, the following "I/O Test" screen appears. This screen is used to check that there is no problem with the V606e interfaces and touch switch operation.

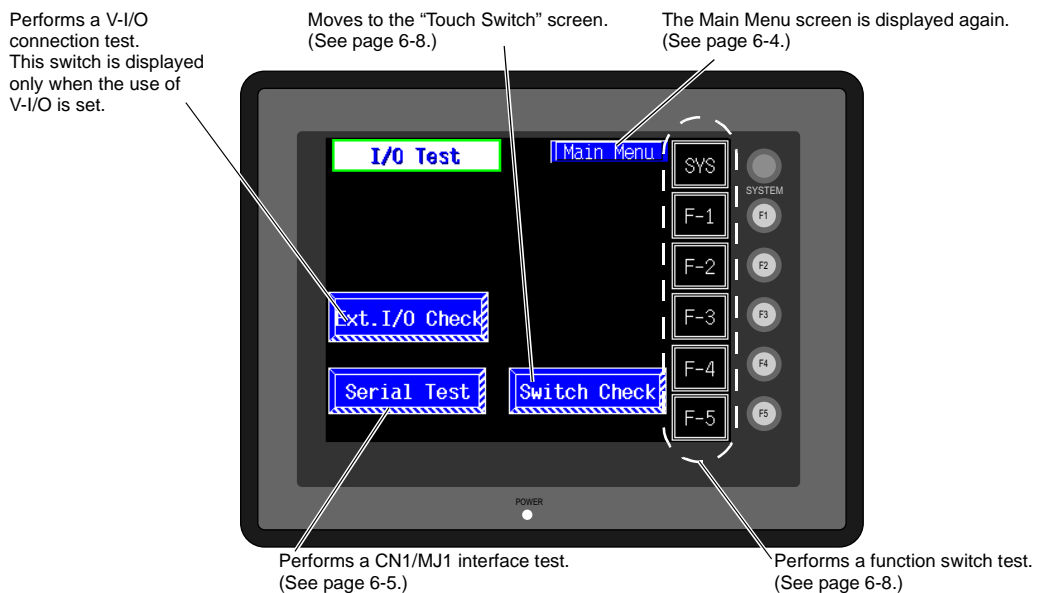

1-1. Serial Connection Test

This is a signal test for communications through the CN1 or MJ1 connector. Perform this test if the communication is not successful when transferring screen data through MJ1, connecting the PLC using CN1, or selecting multi-link 2, temperature controller/PLC2Way or PLC for MJ1, or connecting the card recorder or serial extension I/O.

CN1 Test

RS-232C signal test

Turn the [CN1] and [RS232C] switches on.

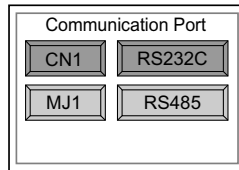

- SD/RD Test

Check the signals [SD] and [RD].

1. Install a jumper between pins 2 and 3 of CN1 on the backside of the V606e unit.
2. Press the [Self-Loop Test] switch. When the [OK] lamp lights up, the test is successfully completed.

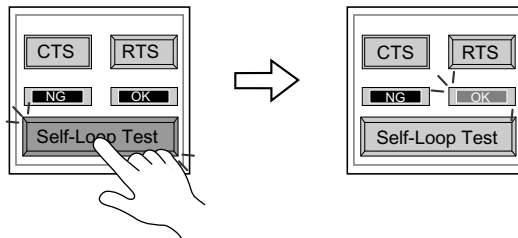

* If the [NG] lamp lights up, consult your local distributor.

- CTS/RTS Test

Check the signals [CTS] and [RTS].

1. Install a jumper between pins 4 (RTS) and 5 (CTS) of CN1 on the backside of the V606e unit.
2. Press the [RTS] switch and check that both [RTS] and [CTS] lamps light up at the same time. Press the [RTS] switch again and check that both [RTS] and [CTS] lamps go off at the same time.

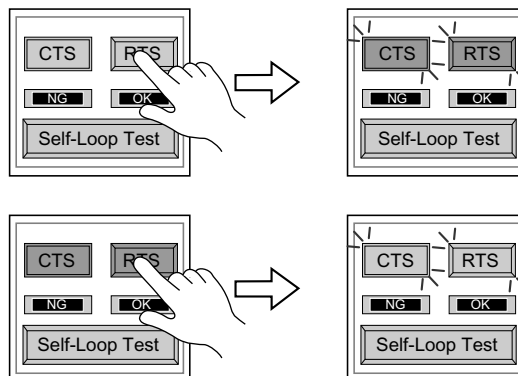

RS-485 signal test

Turn the [CN1] and [RS485] switches on.

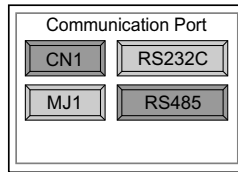

- SD/RD Test

Check the signals [SD] and [RD].

1. Install a jumper between pins 12 and 24 and between pins 13 and 25 of CN1 on the V606e unit.
2. Press the [Self-Loop Test] switch. When the [OK] lamp lights up, the test is successfully completed.

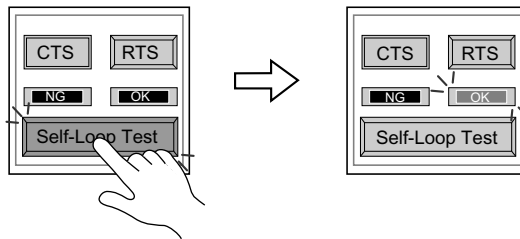

* If the [NG] lamp lights up, consult your local distributor.

- CTS/RTS Test

Check the signals [CTS] and [RTS].

1. Install a jumper between pins 14 (+RTS) and 19 (+CTS) of CN1 and between pins 17 (-RTS) and 18 (-CTS) on the backside of the V606e unit.
2. Press the [RTS] switch and check that both [RTS] and [CTS] lamps light up at the same time. Press the [RTS] switch again and check that both [RTS] and [CTS] lamps go off at the same time.

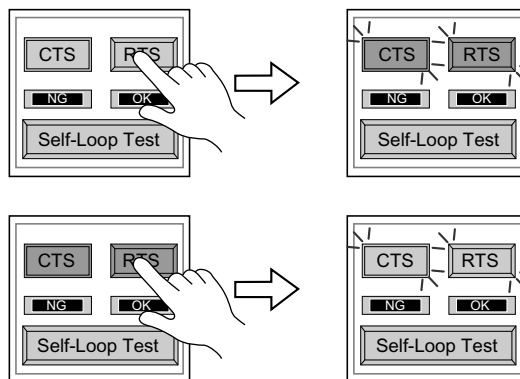

MJ1 Test

RS-232C signal test

Turn the [MJ1] and [RS232C] switches on.

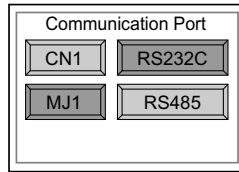

- RS-232C Self-loop Test

Check the signals [SD] and [RD].

Connect the data transfer cable (V6-CP) to CN1 for the test.

1. Set the adaptor ADP25-9 (attached to V6-CP) to the cable V6-CP. Connect the modular jack side of the cable to MJ1 and the ADP25-9 side to CN1.

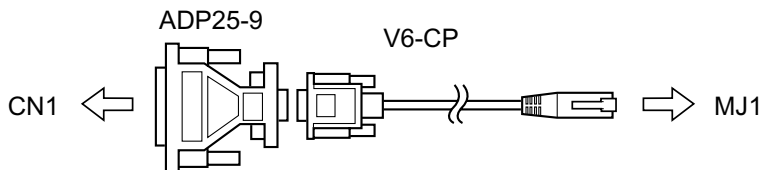

2. Press the [Self-Loop Test] switch. When the [OK] lamp lights up, the test is successfully completed.

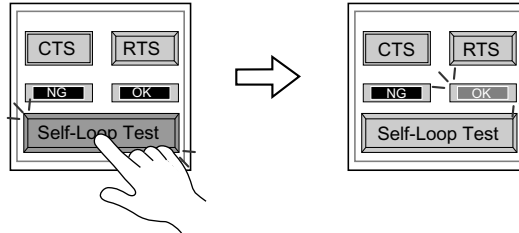

* If the [NG] lamp lights up, consult your local distributor.

RS-485 signal test

If you would like to perform MJ1 RS-485 signal test, consult your distributor.

1-2. SYSTEM & Function Switch Test

Check operations of six switches provided vertically on the right side of the V606e panel. Press the switch, and check that the lamp on the screen lights up while the switch is held down.

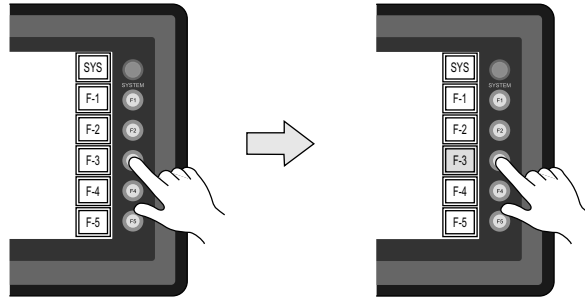

1-3. Touch Switch Test

If a touch switch does not activate at all or if an operation is performed without pressing any touch switch, check that the touch switches on the V606e panel are working properly.

1. Press the [Switch Check] switch. Grids appear on the screen as shown below.

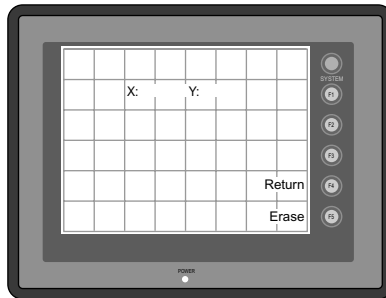

2. Press a position on the panel, and check that the pressed position turns white. The switch is activated normally when the pressed position turns white. To move back to the "I/O Test" screen, press the [F4] switch. To delete white dots, press the [F5] switch.

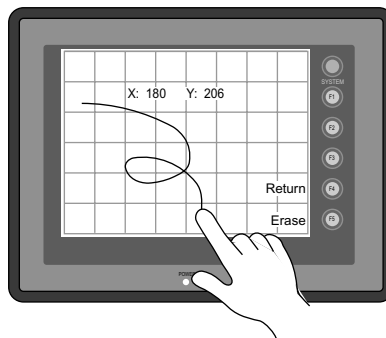

3. If a position different from the pressed position turns white, refer to "Touch Switch Adjustment" on the next page and adjust the touch switch position.

Touch Switch Adjustment

If a position different from the pressed position turns white on the touch switch test screen, follow the steps described below to adjust the touch switch position.

1. Hold down the [SYSTEM] switch and press the [F2] switch on the touch switch test screen.

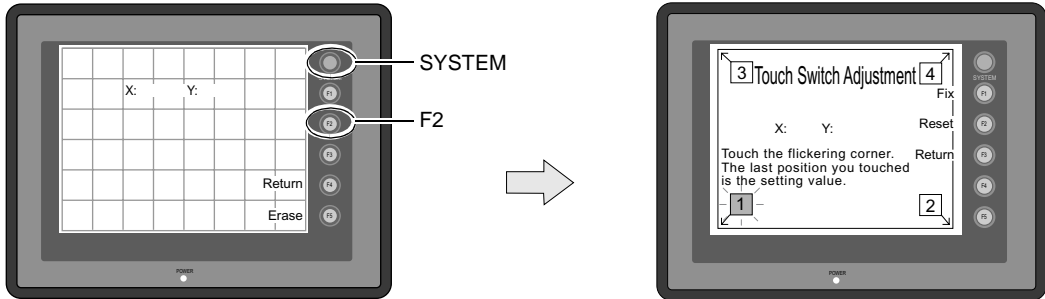

2. Press on "1" that is flashing at the corner on the touch switch adjustment screen. When the finger is released, a beep sounds and the position is set. "2" flashes.



3. Press on "2" that is flashing at the corner. When the finger is released, a beep sounds and the position is set. "3" flashes.



4. Press on "3" that is flashing at the corner. When the finger is released, a beep sounds and the position is set. "4" flashes.

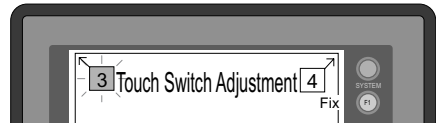

5. Press on "4" that is flashing at the corner. When the finger is released, a beep sounds and the position is set.

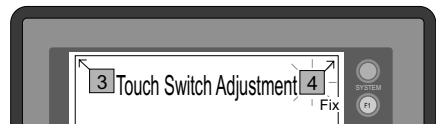

6. To re-set the positions, press the [F2] switch and follow step 2 and later.
7. Press the [F1] switch. A long beep sounds and the positions are determined. The touch switch test screen is displayed again.
8. To cancel the setting, press the [F3] switch. The touch switch test screen is displayed again.

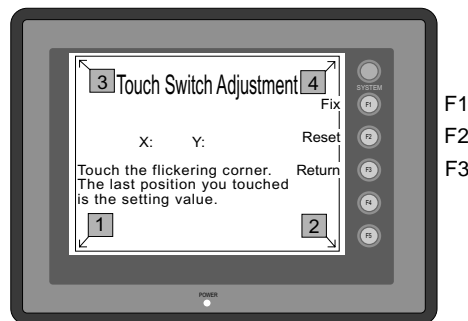

2. Memory Card Screen

When the [Memory Card] switch on the “Main Menu” screen is pressed, the following [Memory-Card] screen appears.

This screen is used to transfer screen data between the V606e and a memory card. The procedure for transferring data is described below.

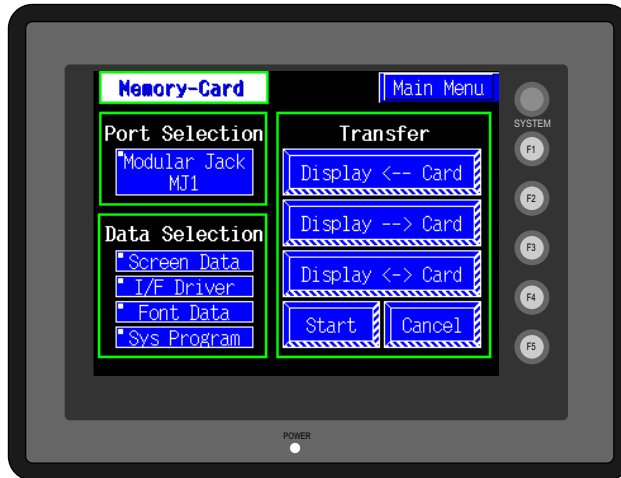

1. Connecting the CREC
Connect a card recorder CREC (using the CREC-CP cable included with the CREC) to the MJ1 port.
2. Mounting the Memory Card
Insert a memory card in to the card recorder (CREC).
3. Memory Card Information
Press the [Modular Jack MJ1] switch.
The memory card information contained in the inserted memory card is indicated. Switches in the “Data Selection” field and “Transfer” field become active.

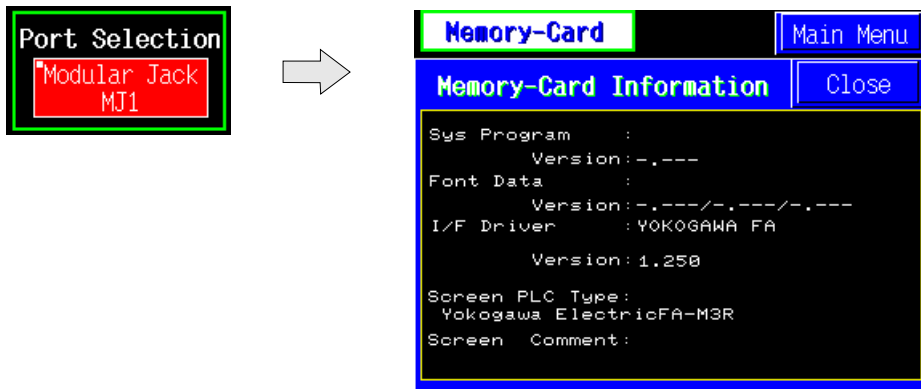

To move back to the previous screen, press the [Close] button.

4. Data Selection and Transfer Selection

In the "Transfer" field, select [Display <-- Card], [Display --> Card] or [Display <-> Card]. Press the desired switch to turn the switch on. Multiple switches can be pressed in the "Data Selection" field.

Data selection

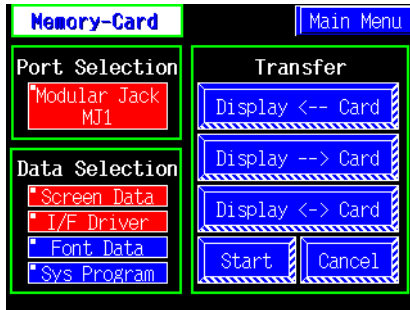

Transfer selection

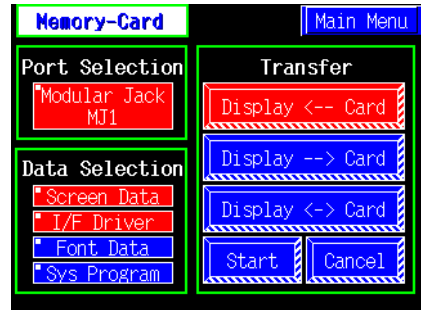

5. Starting Data Transfer

Press the [Start] switch. Data transfer is started. During data transfer, the [Start] switch changes into [Busy] and flashes. When data is transferred, the following message is displayed.

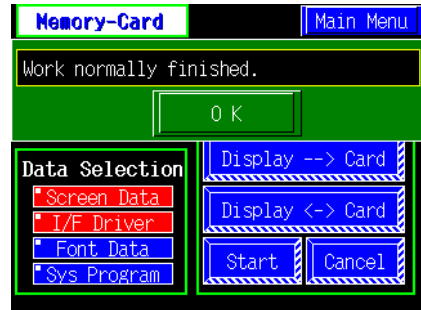
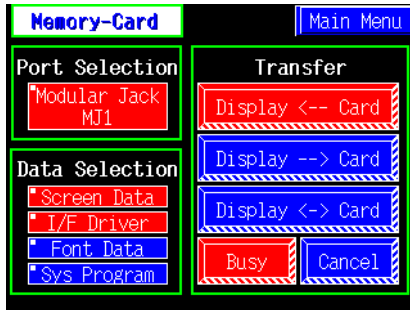

Press the [OK] switch.

Messages during Data Transfer

If an error occurs during data transfer, the message window shown on the right is displayed.



The kinds and the contents of the messages are shown below. The same messages are used for the memory card and CF card. When using the CF card, the "memory card" in the explanation should read as the "CF card".

| Messages | Contents |
|-----------------------------------|---|
| Work normally finished. | The specified operation has been concluded normally. |
| CREC not connecting | No card recorder is connected when selecting a modular jack. |
| CREC Communication Error | A communication error occurred between V606e and CREC when selecting a modular jack. |
| Memory-Card not setting | Memory-Card not setting |
| Memory-Card Capacity over | Cannot write the data into a memory card because the data size in V606e is larger than the capacity of a memory card. |
| Write Protect: ON | Cannot write data into a memory card because the write protect switch in a memory card is ON. |
| Writing Error occurred. | The error occurred while writing data into a memory card. |
| Selected data does not exist. | The data in the reading target does not exist. |
| V6 type is different. | The specified type of the data in V606e is different from the type of the memory card data. |
| Selected data can not be read. | The data in a memory card cannot be read. |
| Reading Error occurred. | The error occurred during writing data into a flash ROM of V606e. |
| Data discrepant | There is some discrepancy in data, when comparing data between a memory card and V606e. |
| Screen data on V6 will be broken. | Warning about data destruction in V606e that may occur when transferring the font data larger than the present data from a memory card to V606e. (The [OK] switch continues transferring; the [Cancel] switch stops transferring.) |
| Undefined Error occurred. | The error occurred due to some cause other than mentioned above. |

3. Communication Parameter Screen

When the [Comm. Para.] switch on the Main Menu screen is pressed, the “Comm. Param.” screen, shown below, is displayed.

This screen is used to check the V606e communication parameter settings.

The Main Menu screen is displayed again.

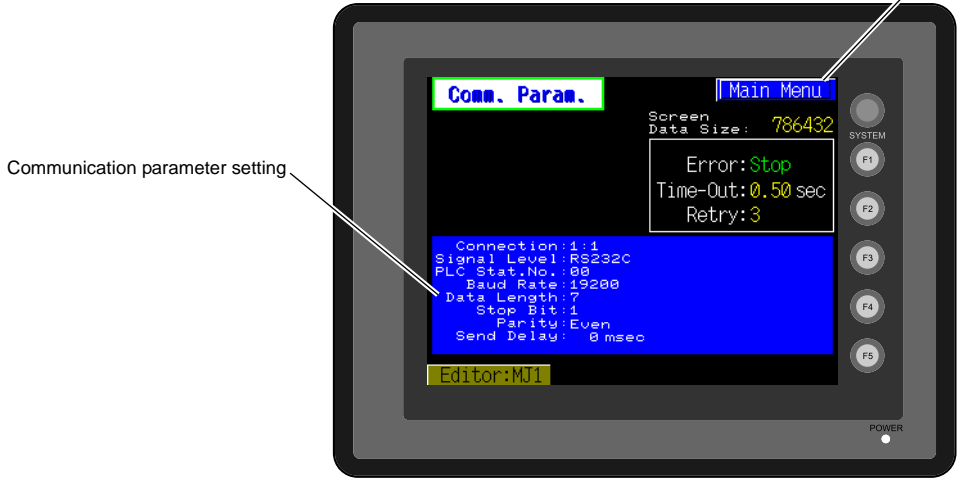

Communication parameter setting

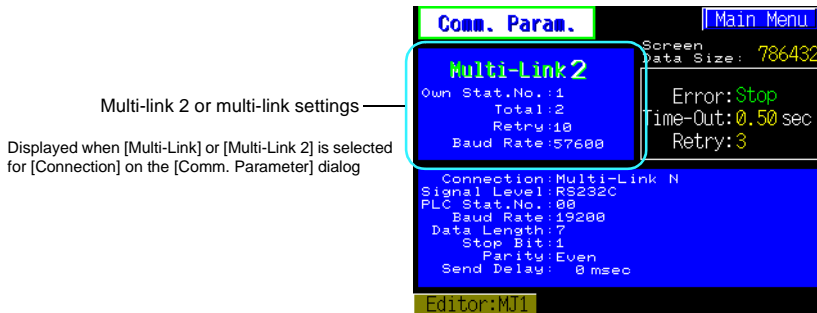

Multi-link 2 or multi-link settings

Displayed when [Multi-Link] or [Multi-Link 2] is selected for [Connection] on the [Comm. Parameter] dialog

4. SRAM/Clock

- The SRAM/Clock setting is effective with V606eX20 only.
- To use the built-in clock of the V606e or to use the SRAM memory or cassette, it is necessary to select [SRAM/Clock Setting] from the [System Setting] menu and make the SRAM/clock setting. For the setting procedure, refer to the Reference Manual.
- Be sure to set the battery when using the built-in clock of the V606e or the SRAM memory or cassette. Without battery, the contents in the SRAM or clock data will not be retained. If the battery is not connected, the message “Data has some error. Error: 161 (24:)” is displayed on the Main Menu screen or “Format required.” is displayed on the “SRAM/Clock Adjust.” screen.

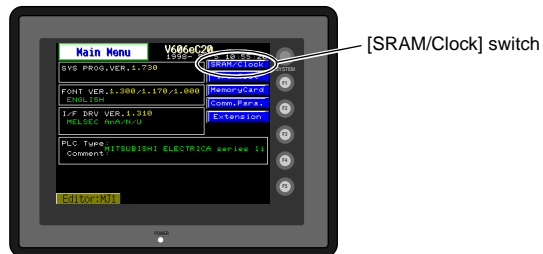

- When the [SRAM/Clock] switch on the Main Menu screen is pressed, the following “SRAM/Clock Adjust.” screen appears. This screen is used for adjusting the built-in calendar and for initializing the SRAM area.

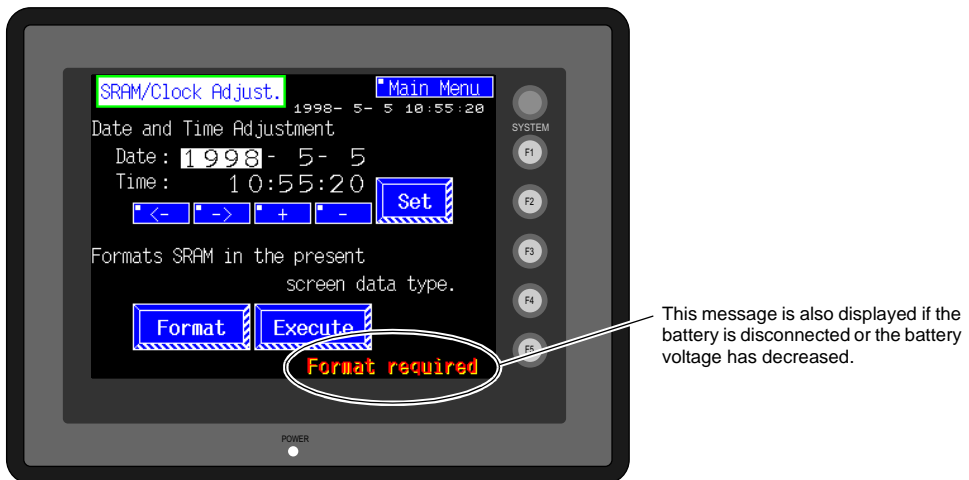

Date and Time Setting

1. Move the cursor using the [←] / [→] switch, and change the value by pressing the [+] / [-] switch.
2. When the desired date and time are set, press the [Set] switch to determine the setting.
3. The calendar data is updated as set.

Initializing SRAM

When the SRAM memory or cassette is initialized, the data contained is cleared. Double-check before initializing the SRAM memory or cassette.

1. Press the [Format] switch and the [Execute] switch.
2. The SRAM area is initialized in the current screen data format. When initialization has been completed, the message “**Format Completed**” is displayed.

5. Extension Program Information

When the [Extension] switch on the Main Menu screen is pressed, the following “Extension Prog. Info.” screen appears.

The driver setting and parameter setting for temperature controller/PLC2Way communication, ladder transfer function, Modbus slave communication, etc. are displayed.

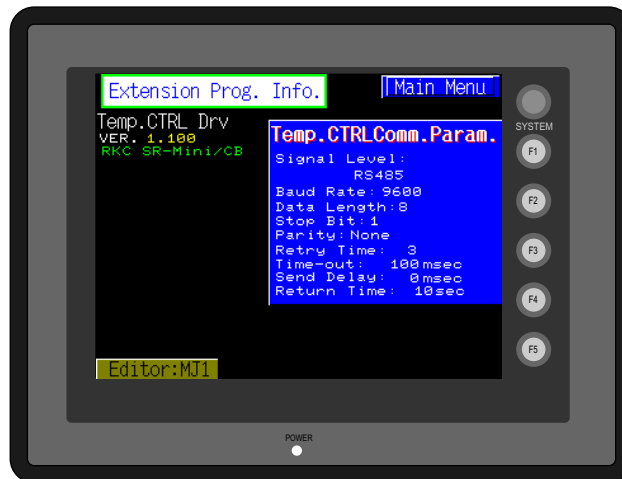

6. Extended Function Setting

When the [Editor: MJ1] switch on the Main Menu screen is pressed, the following "Extended Function Setting" screen appears.

Set the baud rate to be used when transferring screen data between the V606e and a modem.

1. Select the desired baud rate using the [↑] / [↓] switch, and press the [Setting Finished] switch. (Setting range: 4800, 9600, 19200, 38400, 57600, 115200)
 - * The function switches and switches on the Main Menu screen are not valid for 15 seconds after the [Setting Finished] switch is pressed.
 - * When the [Setting Finished] switch is pressed, an AT command is automatically sent to the modem and the baud rate used between the V606e and the modem is set.
2. The [Main Menu] (local main) screen is displayed automatically. [Modem Connect Mode] automatically appears at the right side of [Editor: MJ1].
3. To transfer screen data without a modem, select "Not used" for [Modem Comm. Baud Rate].
For screen data transfer while a computer is connected with V6-CP, specify [Not Used] for [Modem Comm. Baud Rate].

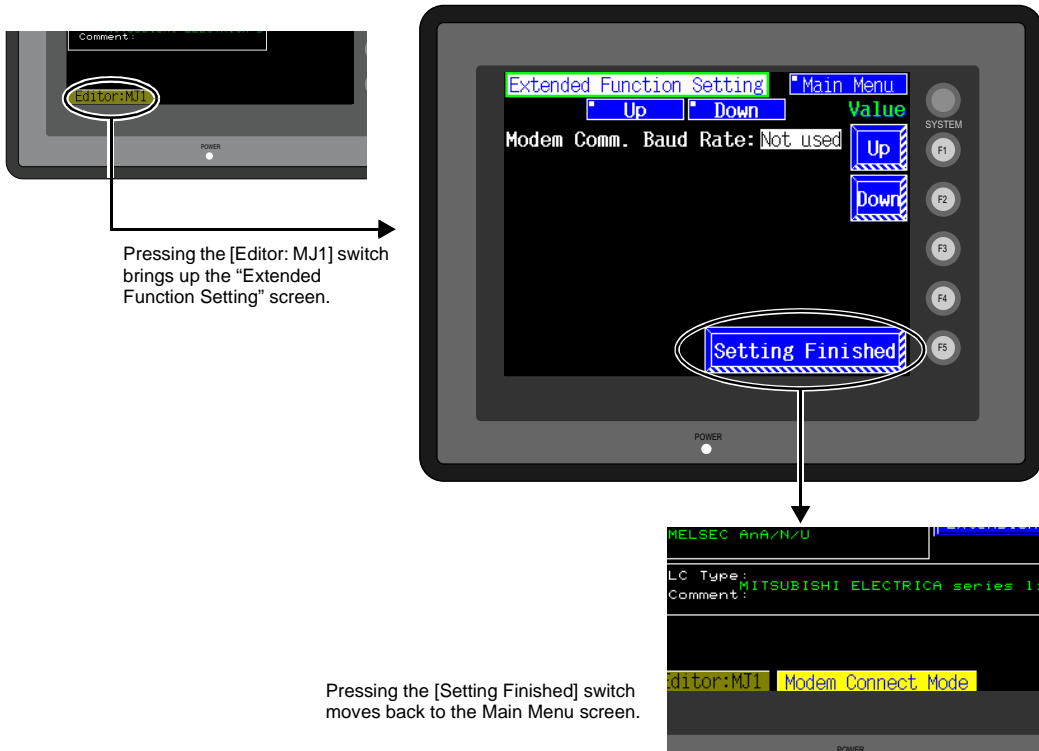

7 Error Correction

1. Error Messages
2. Troubleshooting

1. Error Message

There are five kinds of error messages displayed on the V series:

1. Communication error
2. Check
3. Warning
4. SYSTEM ERROR
5. Touch switch is active

1. Communication Error

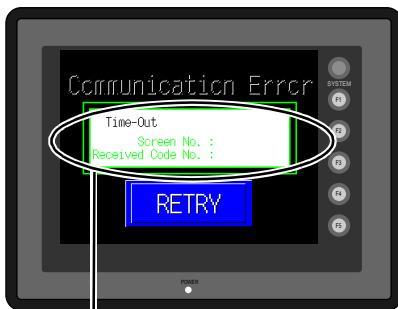

* When you go to [Comm. Parameter], bring up the [Detail] tab window and set [Continue] for [Comm. Err. Handling], a screen like the one shown below is displayed.

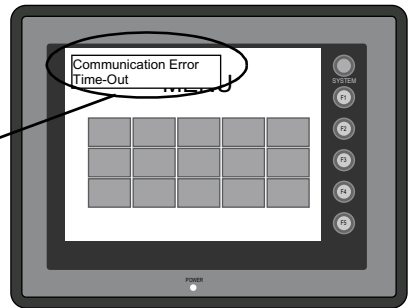

| Error Message | Contents | Solution | Remarks |
|---------------|--|---|---------|
| Time-Out | Although a request to send is given to the PLC, no answer is returned within the specified time. | 1. Check the communication parameters. 2. Check the cables and wiring. | 1 |
| | | 3. Data may be disrupted because of noise. Fix noise. | 2 |
| Parity | An error occurred in parity check. | 1. Check the cables and wiring. | 1 |
| | | 2. Data may be disrupted because of noise. Fix noise. | 2 |
| Framing | Although the stop bit must be [1], it is detected as [0]. | 1. Check the communication parameters. 2. Check the cables and wiring. | 1 |
| | | 3. Data may be disrupted because of noise. Fix noise. | 2 |
| Overrun | After one character is received, the next character is received before internal processing is completed. | 1. Check the communication parameters. | 1 |
| | | 2. Data may be disrupted because of noise. Fix noise. | 2 |
| Check Code | The check code in the PLC response was not correct. | 1. Check the communication parameters. | 1 |
| | | 2. Data may be disrupted because of noise. Fix noise. | 2 |

* If the above error messages are displayed on the unit without establishing communication between V606e and PLC, test the solution of remark "1."
If the error occurs suddenly in communication, test the solution of remark "2."

| Error Message | Contents | Solution |
|---|---|--|
| Error code received | The PLC sent an error code (NAK). | Examine the CPU error code and solve the problem. |
| Break | The PLC's SD (TXD) remains at the low level. | Examine the connection between the PLC's SD (TXD) and the V series RD (RXD). |
| Invalid memory (applicable to MITSUBISHI CPU) | You specified an address that exceeds the memory range of the PLC that you are linked to. | Check the type and range of memory that you set. |
| Invalid CPU model (applicable to MITSUBISHI CPU) | The PLC currently being supported does not have a corresponding CPU. | Confirm whether or not the CPU that you are using can be used with the V series. |
| Format | The code of the received data is invalid. | Check 1, 2, 3 described below. |
| Compare (applicable to HIDIC S10) | Transmission data and received data are different. | Check 1, 2, 3 described below. |
| NAK (applicable to Allen-Bradley PLC) | A NAK code is received. | Check 1, 2, 3 described below. |
| TNS discrepant (applicable to Allen-Bradley PLC) | Transmitted TNS data and received TNS data are not in agreement. | Check 1, 2, 3 described below. |
| Communication Error | An unclear communication error is detected. | Check 1, 2, 3 described below. |
| Count error (applicable to MITSUBISHI CPU and Q link unit) | The expected data amount is different from the count value. | Check 1, 2, 3 described below. |
| Command error (applicable to MITSUBISHI CPU and Q link unit) | The response code differs from the expected code. | Check 1, 2, 3 described below. |
| Invalid cassette (applicable to MITSUBISHI ACPU) | This cassette is not included in the memory cassettes currently being supported. | Contact your local distributor. |
| Password error (applicable to MITSUBISHI QCPU) | The password is incorrect. | Contact your local distributor. |

Solution

1. Confirm link unit settings.
(After making settings, cut power to the PLC.)
2. Go to the editor (V-SFT) and confirm the settings in the [Comm. Parameter] dialog in the [System Setting] menu.
3. If errors only occur from time to time, it is possible that there is a noise-based communication error.
 - * If you still cannot solve the error even after following the suggestions above, contact your local distributor.

2. Check

| Error Message | Contents | Solution |
|---|---|--|
| Screen No. Error | There is no setting for the received screen. | At the start of communications, the V606e regards the value in the read area "n + 2" as the screen number. Check that the value in the read area "n + 2" is an existing screen number on the PLC. |
| Data has some error. Error : XX (XX : XXX) | There is an error in the created screen data. | "Error : XX (XX : XXX)" indicates the edited screen and the contents of the error. For the error details and solutions, refer to the Reference Manual (Function) and correct screen data. |

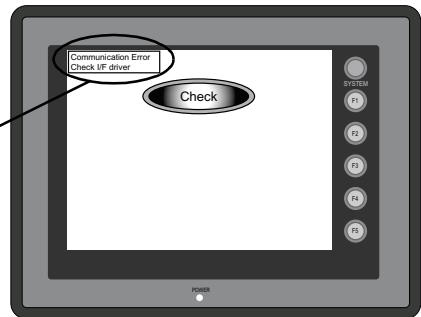
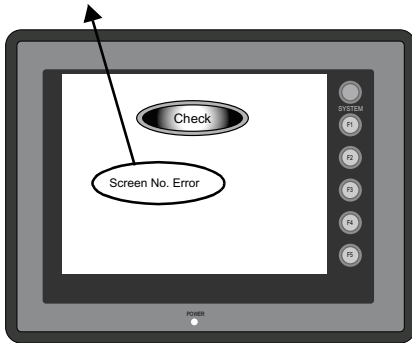

| Error Message | Contents | Solution |
|---|---|--|
| Communication Error Check I/F driver | Although a request to send is given to the computer, no answer is returned within the specified time. | The I/F driver for simulator is transferred. If you do not use the simulator, uncheck [Use Simulator] before transferring data. |

3. Warning

An error may be displayed on the Main Menu screen during data transfer.

This is a warning message.

For the warning details and solutions, refer to the Reference Manual (Function) and correct screen data.

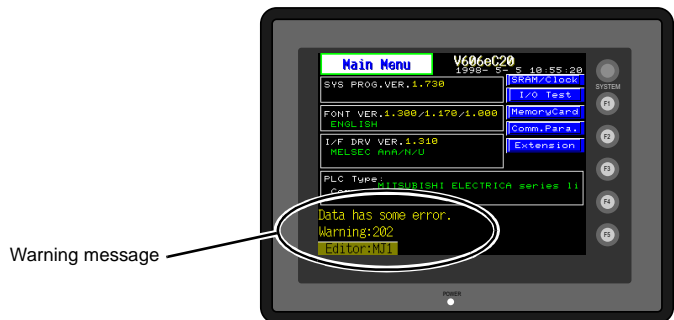

4. SYSTEM ERROR

When a system error is detected, the following error screen is displayed on the V606e.

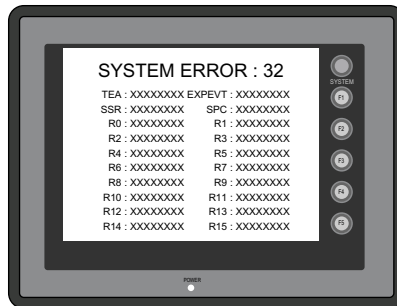

ERROR: XX

- 1: Watch dog timer error
- 11: Switch table error
- 30: Request for displaying full error
- 31: Memory allocation system error
- 32: General exceptions/MMU address system error
- 33: RTOS system error
- 34: Memory error
- 35: Inaccurate memory error

The source of the error could be one of the following three problems. Contact your local distributor.

- 1) Program crash due to noise
- 2) Hardware problem
- 3) Bad program

Solve relevant problems by following the directions in "Troubleshooting" (page 7-5).

If the problem persists, contact your local distributor.

5. Touch Switch is Active

If the power is turned off while a touch switch is activated, the error screen shown on the right is displayed.

Remove your finger from the screen.

If the error screen remains displayed, contact your local distributor.

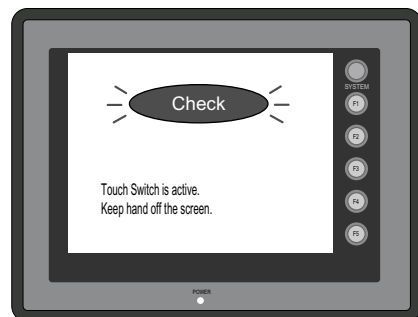



2. Troubleshooting

In the Event of an Error

Perform the steps below:

1. If the current error matches a symptom in the following table, correct it by following the instructions provided.
2. If the error does not match the symptoms in the table, contact your local distributor. Please provide the distributor with the information on the MONITOUCH model, serial number, symptom of the error, error message (if shown), etc.

Probable Symptoms

| Symptom | Cause | Solution |
|---|---|--|
| <p>MONITOUCH is connected to the PLC; however, communication fails. "Communication Error: Time-Out" appears on the screen.</p>  | <p>Probable causes are:</p> <ol style="list-style-type: none"> 1) Cables are not connected correctly or any cable is disconnected. 2) PLC parameter settings are not correct or disagree with the MONITOUCH settings. 3) The MONITOUCH is faulty. | <p>Solutions are:</p> <ol style="list-style-type: none"> 1) Check the cable connection. 2) Recheck the PLC parameter settings. 3) Perform a self-loop test on the "I/O Test" screen (page 6-5). If the test is not successful, please return the MONITOUCH to your local distributor immediately. |
| <p>Communications have been successful. However, opening a certain page always causes a "Communication Error: Error code received" error.</p>  | <p>The error code denotes a PLC error (NAK).</p> <ol style="list-style-type: none"> 1) When the error code appears only on a certain screen, a memory address that does not exist on the PLC may be set on the MONITOUCH screen. 2) When the error code appears at power-on, a memory address that does not exist on the PLC may be set for communication parameters, buffering area, initial macro, etc. | <ol style="list-style-type: none"> 1) Check if any address outside the allowable range for PLC memory is set on the screen. 2) Check if any address outside the allowable range for PLC memory is set for communication parameters, buffering area, initial macro, etc. |
| <p>Communications have been successful. However, "Communication Error: Parity" or "Communication Error: Framing" suddenly occurs.</p>  | <p>Noise may cause the error.</p> | <p>Check if appropriate measures are taken against noise.</p> <p>Example: Check if communication and power cables are bundled together. Try to attach a ferrite core to the communication cable. Try to attach a noise filter to the power supply, etc.</p> |

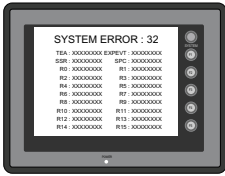
| Symptom | Cause | Solution |
|---|---|--|
| <p>"SYSTEM ERROR: xx" occurs.</p>  | <p>The following causes are probable, depending on the symptoms.</p> <ol style="list-style-type: none"> 1) Turning the power off and back on corrects the error. ↓ Communication failed because of improper timing. 2) Turning the power off and back on does not correct the error. ↓ A certain condition always causes the error. Or the MONITOUCH is faulty. | <ol style="list-style-type: none"> 1) If communication is stable after turning the power on again, continue and observe operation. 2) Make a note of the information on error number, etc. displayed on the screen and contact your local distributor. |
| Switches do not work. | <ol style="list-style-type: none"> 1) Switches do not work in the RUN mode. A beep sounds. ↓ Is the switch interlock enabled? 2) Switch activation position is wrong. On the "I/O Test" screen displayed from the Main Menu screen, press the [Switch Check] switch. On the touch switch test screen, a position different from the pressed position is activated. ↓ The switch activation position may be misaligned. 3) Switches do not work even in the STOP mode. On the "I/O Test" screen displayed from the Main Menu screen, press the [Switch Check] switch. When the touch switch test screen is pressed, nowhere is activated. ↓ MONITOUCH switches may be faulty. | <ol style="list-style-type: none"> 1) Check the settings of switch functions, etc. on the V-SFT editor. 2) Perform a touch switch adjustment (page 6-9). 3) Return the MONITOUCH to your local distributor. |
| The screen becomes dark or black. | <ol style="list-style-type: none"> 1) Touching the screen restores it to the previous illuminated state. ↓ The backlight operates automatically as preset. 2) Touching the screen does not restore it. However, the POWER lamp is lit. ↓ The backlight may be at the end of its life. Or the MONITOUCH may be faulty. | <ol style="list-style-type: none"> 1) The time for turning off the backlight can be changed on the V-SFT editor. 2) Return the MONITOUCH to your local distributor. |
| Screen data cannot be transferred. | <ol style="list-style-type: none"> 1) Screen data transfer has never succeeded. ↓ There may be some errors in the settings on the computer. 2) Screen data transfer was possible, but is disabled now. ↓ The MONITOUCH may be faulty. Or, there may be some errors in settings. | <ol style="list-style-type: none"> 1) In the [Transfer] dialog box on the V-SFT editor, decrease the baud rate by one level. Also check that the correct COM port is selected. 2) Check if the modem connection mode is selected. ("Modem Connect Mode" displayed at the bottom of the Main Menu screen denotes the mode) Also perform an RS-232C self-loop test (page 6-5). |

8

Inspection and Maintenance

1. Inspection and Maintenance
2. Warranty Policy

1. Inspection and Maintenance



Be sure to turn off the power before conducting inspection or maintenance. Failure to do so could cause an electric shock or damage to the unit.

Daily Inspection

- Check that the screws on the MONITOUCH are tightened firmly.
- Check that the connectors and terminal screws used for connection with other devices are tightened firmly.
- If the display surface or frame is dirty, wipe it with a soft cloth soaked in alcohol (commercially available).
- Conduct periodical inspection once or twice a year. The number of inspections may be increased as necessary if facilities are relocated or modified, or the environment is hot, humid, or dusty.

Periodical Inspection

Inspect the following points periodically.

- Are the ambient temperature and humidity appropriate?
0 to +50°C, 85%RH or less
- Are the environmental conditions appropriate?
- Does the atmosphere contain no corrosive gas?
- Is the source voltage in the allowable range?
24 VDC \pm 10%
- Are the MONITOUCH mounting screws tightened firmly?
- Are the connectors and terminal screws used for connection with other devices tightened firmly?
- Is the lithium primary battery within the expiry date?

2. Warranty Policy

Inquiries about Failure

Please direct inquiries about failure or repair to your local distributor. Your information on the MONITOUCH model, serial number, symptom of the failure, error message (if shown), etc. will be appreciated.

- * An inquiry form is provided on the final page (page 8-3) of this chapter. The form may be used for your inquiry.

Warranty Period

The product is under warranty for one year after the date of purchase or delivery to the specified place. On the assumption that the maximum stock period of the product after manufacture is 6 months, the warranty period is limited to 18 months (checked by the serial number) after manufacture. When a warranty period is specified in the contract, however, the period in the contract takes precedence.

Free-of-charge Repair

If the product fails before the expiry of the warranty, it will be repaired free of charge. However, repair of any failure resulting from the causes below will be chargeable even within the warranty period.

- Breakage of or damage to the appearance (case or surface sheet), touch switches, LCD, or other components due to dropping, impact, or mishandling
- LCD or backlight at the end of life
- Fusion of a printed circuit board pattern associated with connection to external devices, or fusion of a pattern in the terminal block or connector section of a printed circuit board caused by short-circuiting of external load circuit
- Overvoltage or different voltage applied due to wiring mistake (power supply terminal, external communication terminal, or other terminal blocks)
- Failure caused by lightning surge
- Failure due to the entry of conductive substances, water, solvent, particles, etc. under inappropriate environmental conditions
- Failure due to inappropriate environmental conditions (e.g. corrosive gas or high humidity)
- Failure due to vibration or impact exceeding the specified level
- Disassembly and modification by the customer or failure obviously resulting from improper handling by the customer

Chargeable Repair

Any failure that occurs after the expiry of the warranty or does not satisfy the requirements for the free-of-charge repair will be repaired on a chargeable basis.

Inquiry Form

| | | | |
|--|-------------------|--|-----------------|
| Your name | | | |
| Company name | | | |
| Contact | E-mail: | | |
| | TEL: | | FAX: |
| Model code (*1) | | | Ser. No. (*1) |
| MONITOUCH version (*2) | SYS. PROG. Ver. : | | I/F DRV. Ver. : |
| Purchased from: (Name of distributor) | | | |
| Date of purchase | | | |
| Symptom (Please describe the symptom of the failure and also include the error message if any is displayed.) | | | |

*1 See the label on the back of the MONITOUCH for the model code and serial number (seven digits plus one letter of the alphabet).

*2 Enter the version if it can be checked. The version is displayed on the Main Menu screen (page 6-3).

Serial number



MEMO

Please use this page freely.

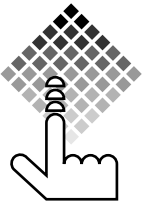

MONITOUCH

Hakko Electronics Co., Ltd.

| | |
|----------------------|---|
| Sales | 890-1, Kamikashiwano-machi, Matto-shi, Ishikawa, 924-0035 Japan TEL (076)274-2144 FAX(076)274-5208 |
| Tokyo Office | TEL (03)3255-0166 FAX(03)3255-0298 |
| Osaka Office | TEL (06)6385-8234 FAX(06)6385-7851 |
| Nagoya Office | TEL (052)789-0096 FAX(052)789-0098 |
| Head Office | 238, Kamikashiwano-machi, Matto-shi, Ishikawa, 924-0035 Japan |